

University of California, Riverside Genomics Building

Detailed Project Program

April 18, 2003

Revised January 30, 2004

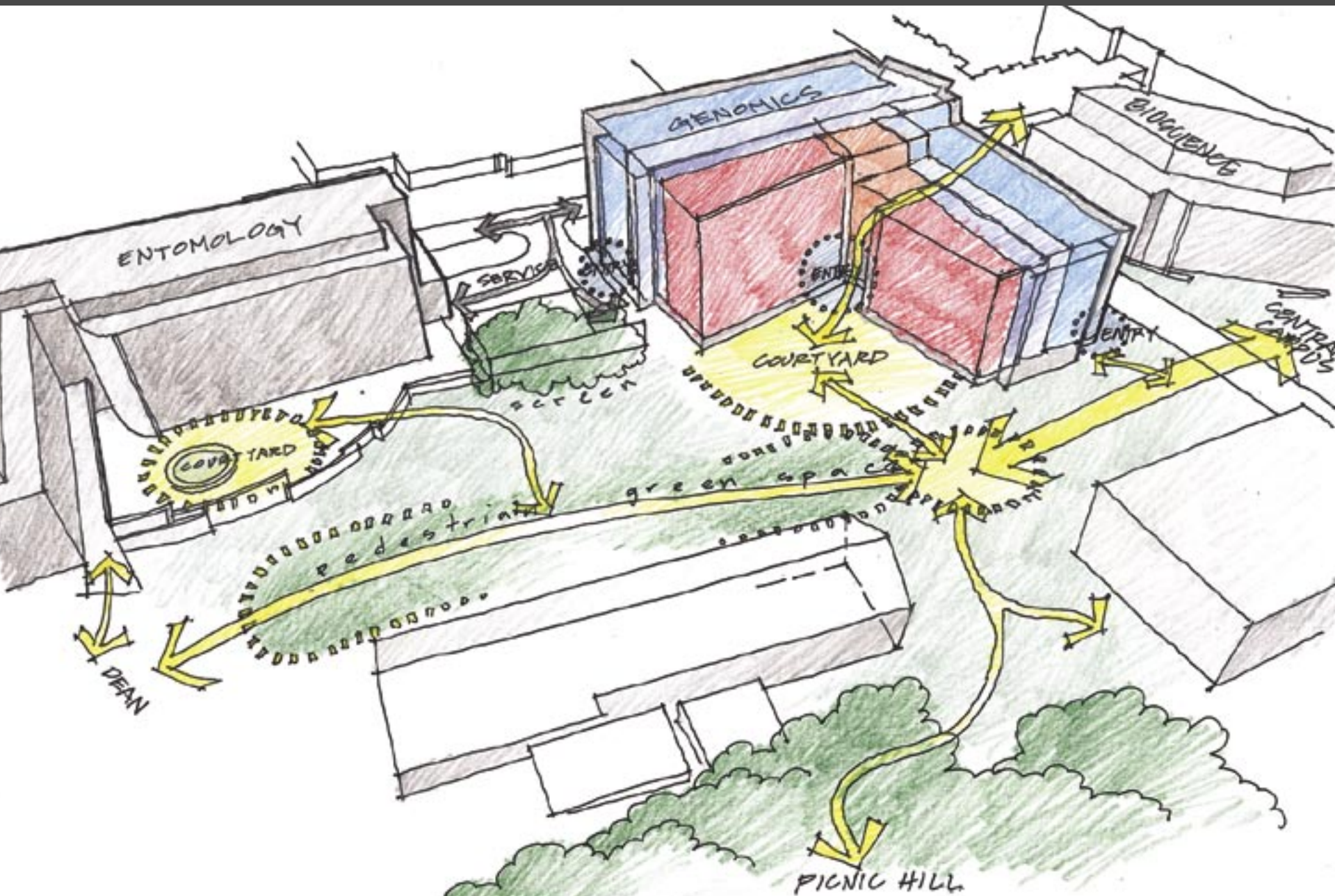

Approval Signatures

University of California, Riverside

Genomics Building

Project No. 950455

Detailed Project Program

REVIEWED AND APPROVED BY:

Stephen R. Angle, Dean
College of Natural and Agricultural Sciences

Gretchen Bolar
Vice Chancellor, Academic Planning and Budget

C. Michael Webster
Vice Chancellor, Administration

Acknowledgments

University of California, Riverside

Office of Academic Planning & Budget

Gretchen Bolar, *Vice Chancellor*
Tim Ralston, *Assistant Vice Chancellor*
Kieron Brunelle, Sr, *Educational Facilities Planner*
Lisa Peloquin, *Sr. Educational Facilities Planner*
Nita Bullock, *Campus Physical Planner*
Joanne Cate, *Principal Administrative Analyst*
Crystal Gillespie, *Administrative Assistant*

DPP Committee

Peter Atkinson, *Associate Professor, Dept. of Entomology, Committee Co-Chair*
Donald Cookskey, *Executive Associate Dean, College of Natural and
Agricultural Sciences, Committee Co-Chair*
Natasha Raikhel, *Distinguished Professor, Dept. of Botany and Plant Sciences*
Zhenbiao Yang, *Associate Professor, Dept. of Botany and Plant Sciences*
Julia Bailey-Serres, *Professor, Dept. of Botany and Plan Sciences*
Brian Federici, *Professor, Dept. of Entomology*
Howard Judelson, *Associate Professor, Dept. of Plant Pathology*
Keh-Shin Lii, *Chair, Dept. of Statistics*
Dmitri Maslov, *Associate Professor, Dept. of Biology*
Shou-Wei Ding, *Assistant Professor, Dept. of Plant Pathology*
Nadine Sayegh, *President, Associated Students of UCR*
Richard Stouthamer, *Representative Academic Senate Committee on Physical
Resources Planning*

Project Management Team

Kieron Brunelle, Sr. *Educational Facilities Planner*
Lisa Peloquin, *Principal Education Facilities Planner*
Ted Chiu, *Associate Director, Design and Construction*
Nita Bullock, *Campus Physical Planner*
Joanne Cate, *Principal Administrative Analyst*

Office of Design and Construction

Dan Johnson, *Assistant Vice Chancellor*
Ted Chiu, *Associate Director*

Office of Environment Health & Safety

Scott Corrin, *UCR Fire Marshal*

Design Team

SRG Partnership, Inc.

Architecture

Dennis Cusack, AIA, *Principal-In-Charge*

Jon Schleuning, FAIA, *Design Principal*

Stephen Korbich, AIA, *Project Architect*

Paschal Johns, AIA, *Project Manager*

Laura Hill, IIDA, *Principal/Programming and Planning*

Jaci Amend, *Project Support Manager*

Diane Dunning, *Project Support Administrator*

Jennifer Gentry, *Project Support Administrator*

Research Facilities Design

Lab Planning

Sean Towne, AIA, *Principal*

kpff Consulting Engineers

Civil Engineering

John Gavan, SE, *Managing Principal*

Richard Davis, PE, *Civil Engineer*

Saiful/Bouquet, Inc.

Structural Engineering

Saiful Islam, PhD, SE, *President*

Affiliated Engineers, Inc.

Mechanical, Electrical and Plumbing Engineering

John McDonald, *Principal/Project Manager*

Mike Beard, *Mechanical Engineer*

Sheri Vu, *Electrical Engineer*

Jun Padilla, *Piping/Fire Protection*

Davis Langdon Adamson

Cost Estimating

Rick Lloyd, *Senior Associate*

Paul Abernathy, *Associate Principal*

Phillip Mathur, *Associate Principal*

Table of Contents

1.0 Executive Summary

1.1 Mission	1-1
1.2 Program	1-3
1.3 Site	1-4
1.4 Concept.....	1-5
1.5 Schedule and Budget	1-7

2.0 Introduction

2.1 Introduction.....	2-1
2.2 Genomics Institute	2-2
2.3 Long Range Development Plan	2-4
2.4 Planning and Design Guidelines.....	2-6
2.5 Planning Process.....	2-6
2.6 Key Program Assumptions	2-7
2.7 Project Goals	2-7

3.0 Program

3.1 Program Overview	3-1
3.2 Preliminary Planning Program	3-1
3.3 Service Yard Program	3-3
3.4 Functional Relationships	3-4
3.5 Lab Design Considerations	3-4
3.6 Room Data Sheets and Diagrams.....	3-10

4.0 Site Analysis

4.1	Campus Planning Context	4-1
4.2	LRDP Goals	4-1
4.3	Site	4-1
4.4	Vehicular Circulation	4-3
4.5	Pedestrian Circulation	4-3
4.6	Utilities	4-3
4.7	Soils and Grading	4-5
4.8	Campus Service Groups Issues	4-6
4.9	Existing Site Analysis	4-8
4.10	Site Planning Principles	4-9
4.11	Site Sections	4-12

5.0 Design Concept

5.1	Project Ideals	5-1
5.2	Site Concepts	5-2
5.3	Site and Building Design	5-5
5.4	Building/Site Design Principles	5-7
5.5	Research Floor Organization	5-9
5.6	Research Labs and Offices	5-9
5.7	Plan Organization	5-11
5.8	Concept Building Relationships	5-12
5.9	Exterior Building Design Goals	5-13
5.10	Interior Building Design Goals	5-14
5.11	Systems Descriptions	5-15

6.0 Budget and Cost Plan

6.1 Basis of Cost Plan	6-1
6.2 Project Budget.....	6-1
6.3 Inclusions.....	6-1
6.4 Exclusions	6-4
6.5 Overall Summary.....	6-6
6.6 Building Component Summary.....	6-7
6.7 Sitework Component Summary.....	6-7

7.0 Schedule

7.1 Overview	7-1
7.2 Detailed Project Program.....	7-1
7.3 Project Planning Guide (PPG).....	7-1
7.4 Design Phases	7-1
7.5 Construction.....	7-1
7.6 Graphic Schedule	7-2

Appendix A

Site Selection Criteria	A-1
-------------------------------	-----

Appendix B

Concept Development.....	B-1
--------------------------	-----

Appendix C

Cost Plan Detail.....	C-1
-----------------------	-----

Appendix D

Building System Criteria - Applicable Codes and Guidelines.....	D-1
Occupancy Designation.....	D-2
Construction Type	D-2
High Rise Requirements	D-2
Architectural Criteria	D-3
Structural Criteria.....	D-3
Mechanical Criteria.....	D-5
Piping Systems Criteria.....	D-15
Electrical Criteria	D-16

Appendix E

Structural Systems Description	E-2
Mechanical Systems Description	E-6
Piping Systems Description	E-14
Electrical Systems Description	E-21

1.0 Executive Summary

1.1 Mission



Campus Aerial View

The mission of the proposed University of California Riverside Genomics Institute is to develop and disseminate new scientific and technical knowledge that will afford economic and social benefits to agriculture, the environment, and human health, thus improving the quality of life. This will be accomplished by making, exploiting, and evaluating the impacts of discoveries in genomics, proteomics, and bioinformatics through focused efforts in: (1) insect genomics, (2) plant cell biology/genomics, (3) microbial genomics, (4) mammalian genomics, and (5) bioinformatics. The Institute will maintain a high level of scientific integrity and social responsibility in its research, educational, and outreach programs.

The University of California Riverside (UCR) is well positioned to participate in the genomics revolution by virtue of a research-active faculty in the biological and agricultural sciences, chemistry, statistics, computer science, social sciences, and humanities. The campus has already committed significant resources to the UCR Genomics Institute (UCRGI) in the form of new faculty positions, support staff, one-time equipment funds, and a modest operating budget. In addition, the campus has made commitments to the Center for Plant Cell Biology, which resides within the UCRGI. A new core instrumentation facility—consisting of 10,000 assignable square feet in highly specialized shared research space. To help fund the facility and the instrumentation it houses, the UCRGI has prepared proposals to philanthropic organizations and assisted faculty in writing multi-investigator proposals for genomics research, thus actively enhancing the funding base available to UCR researchers.

An additional investment of resources for a new, state-of-the-art research facility will position UCR at the forefront of this emerging area. The pay-off will be large because the ability to capture intellectual property and to harness private/public partnerships is likely to determine the capacity of institutions, such as UCR, to adapt to the future. Equally important will be the role that UCR will play in guiding the wise use of these new technologies so that future generations will gain from their implementation.

The Academic Plan for CNAS calls for aggressive growth in the areas of genomics and plant cell biology, adding 17 faculty over the next three to four years, plus a new director position. As described above, this plan builds upon existing strengths within CNAS as well as other academic units on campus. In 2001, these synergies and the potential strength of genomics were recognized in selecting UCR as one of three major cross-campus initiatives for future

resource investment. To fully capitalize on investments already made and UCR's vision for a world class Genomics Institute, a new building is proposed to house these new faculty hires and to bring together existing faculty across a spectrum of genomics-related research.

This proposal provides research laboratories that will serve 217 faculty, researchers and support staff.



Site Concept

1.2 Program



The Genomics building places an emphasis on creating working environments that support and foster synergistic relationships at all levels. Genomics work involves on-site faculty research, graduate education, undergraduate research training, visiting scholars exchange, and public outreach and education. The following objectives add qualitative dimensions to the program and focus on encouraging intellectual interaction and collegiality.

- Create a building that establishes an identity for Genomics yet is fully integrated into the campus fabric, supporting campus planning guidelines and objectives.
- Create an environment that facilitates intellectual stimulation and collaboration between faculty, post-doctoral and graduate students.
- Maximize the research space given the resources available, providing Genomics with a facility that supports high-level research.
- Provide the capability to change and adapt to future space and technological needs.

Space Program Summary	Assignable	%
Research Laboratories	31,000	49
Research Support	14,000	21
Office/Admin/Conference	18,500	29
Building Support	500	1
TOTAL	64,000	100%

1.3 Site



The proposed site for the Genomics building is located north of Entomology I, at the southeast corner of Eucalyptus and Citrus Drives. The site area is approximately 75,000 square feet, or approximately 1.7 acres. There is a grade differential of approximately 20 feet from the high point at the southeast corner to the low point at the northwest corner. Citrus Drive is the west edge of the site, and Eucalyptus Drive is the north edge. The Entomology Annex occupies the site, and is surrounded by parking and lawn areas. This greenhouse is scheduled to be removed in the summer of 2004.

The siting of the Genomics building is strongly influenced by pedestrian circulation and existing Genomics programs in buildings close to the site. The public and the majority of staff will approach the building from the northeast corner of the site, arriving from parking lot #9. Primary university pedestrian circulation will be from the northeast corner of the site. Faculty and students come from the entire CNAS precinct.

Different building footprint variations were discussed during this design process, and additional options should be explored during the next stage of design.

The project will create a hierarchy of private to public space, from the courtyard out to more campus-oriented plazas that tie into the campus pedestrian path systems. This strengthens the pedestrian circulation systems and is consistent with campus planning goals.

The service zone will be shared with Entomology I and will utilize the existing access driveway and service/delivery area.



View from northwest corner of site

1.4 Concept



View from south



View from north



View from east



View from west

The orientation and configuration of the proposed Genomics building responds to the program, the topography of the site, and to key site planning issues. It is configured as an L-shaped building to present both a public side and a campus side. The labs are placed on the street sides of the building and express a formal organization to the public, while the office areas are clustered around a semi-private courtyard. Proposed building materials are UCR brick, concrete and glass, consistent with adjacent buildings and with campus standards. The inside of the courtyard is treated more informally. The building has two entrances: the more public entrance at the northwest corner, and the campus entrance from the courtyard on the northeast corner. The open courtyard space is envisioned as an interactive, casual space for students and faculty.

The first floor is a partial floorplate and contains the street entrance, conference center, limited administration space and building support functions, such as mechanical and service. The second floor opens onto the pedestrian mall courtyard to the east and is a primary entrance and main lobby. This level is the first of four lab floors. Each is dedicated to research labs, lab support, faculty offices and office support. The loading/service area is shared with the existing Entomology I building, and is accessed at the second floor level.

The labs are organized in modules to promote maximum flexibility for size and future adaptation. While planning flexibility allows for a variety of open and enclosed lab suites, the building program designates two-thirds of the lab space as open lab suites and one third as more enclosed, preferably concentrated on one level. Lab support is adjacent to the lab modules. The office support and faculty offices are clustered in close proximity to the labs to promote interaction among faculty members and their teams.

The graduate and post-doctoral students are in shared offices adjacent to faculty offices. Office support spaces, such as conference rooms, copy, mail, and interactive areas will be clustered near faculty offices and distributed throughout the building.

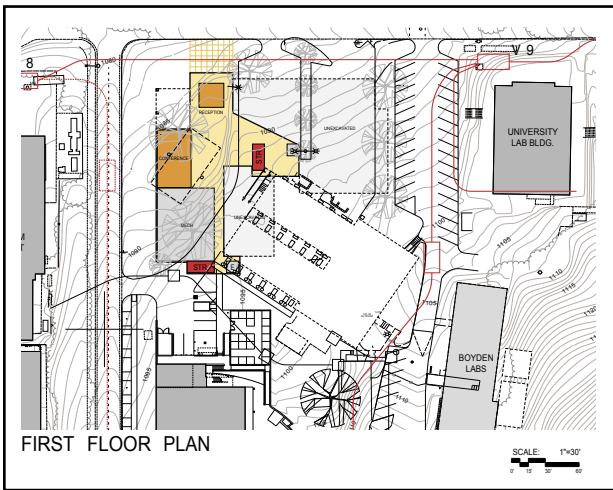
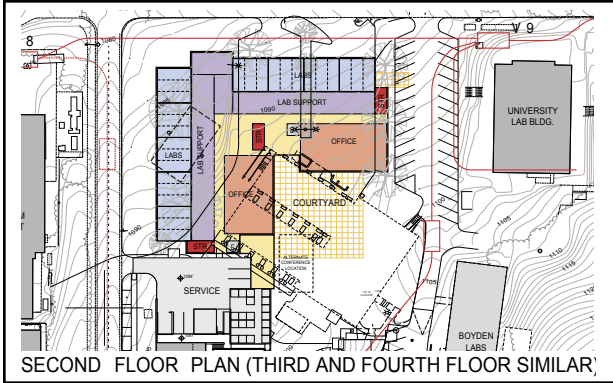

Building Floor Plans

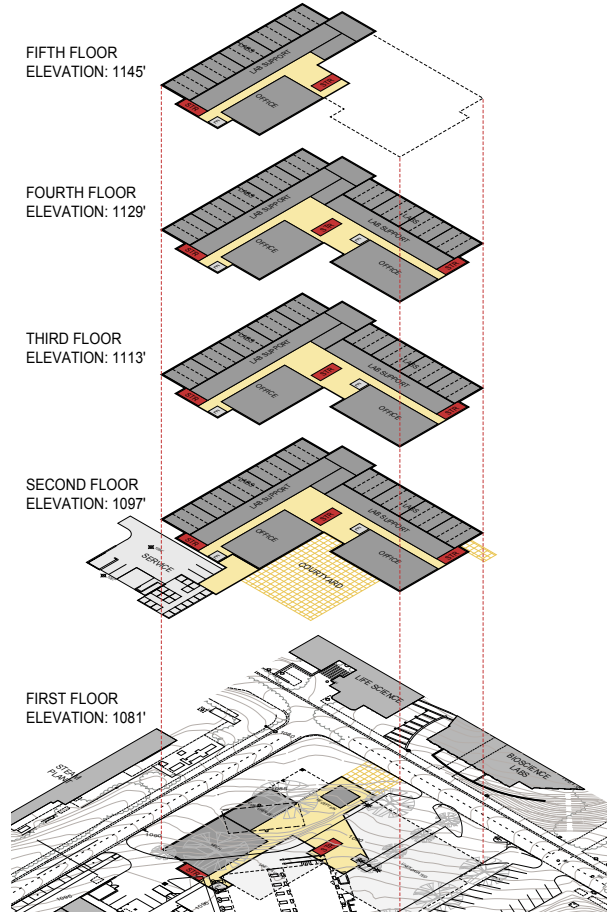

Building Axonometric

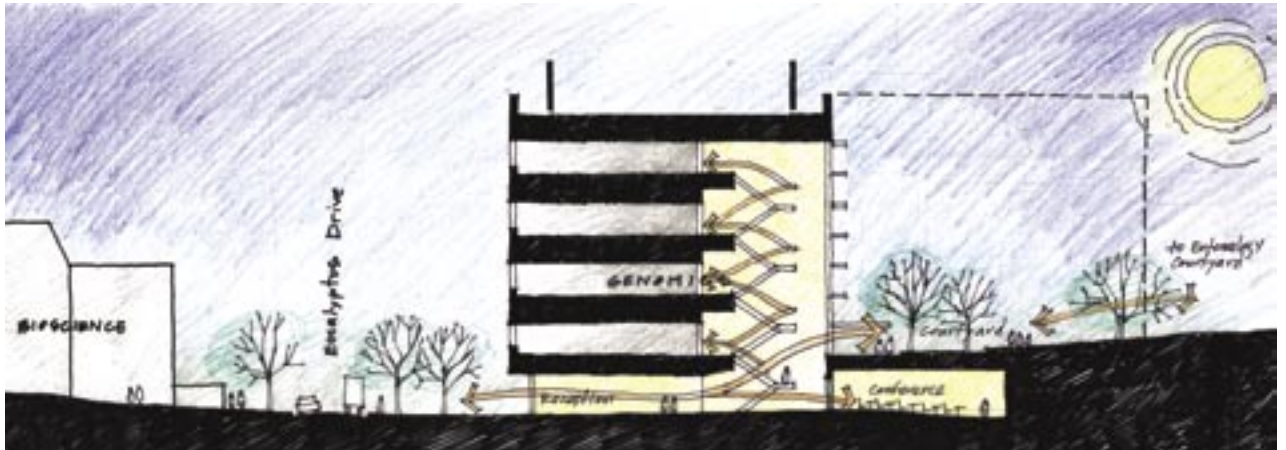

1.5 Schedule and Budget

The Project Planning Guide was completed in the fall of 2003, and the architect selection is scheduled for the spring of 2004. Construction will be completed by spring 2008.

The direct construction cost for the Genomics Building is estimated to be \$37,398,000, which includes escalation to the anticipated mid-point of construction. The total project cost of \$53,000,000 includes 20% for indirect costs.

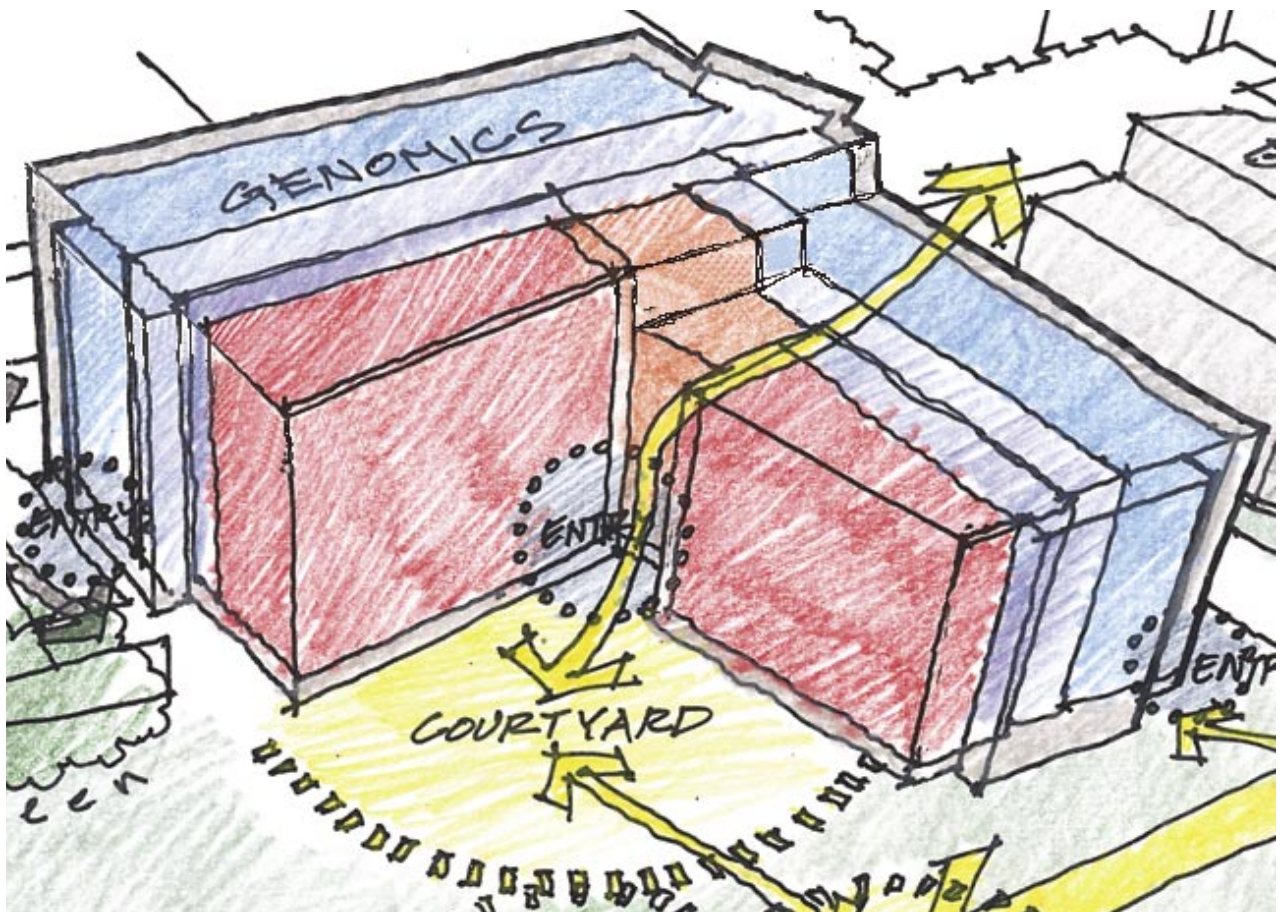

2.0 Introduction

2.1 Introduction

The University of California, Riverside (UCR) has its roots in agricultural research. Recognizing the need for research into the methods and problems of citrus agriculture, the University of California established an experimental research facility in 1907 on 30 acres below Mt. Rubidoux. In 1918, the first citrus experiment station was dedicated on current UCR property at the foot



Campus aerial

of Box Springs mountains, utilizing 370 acres to study citrus and other southern California crops, and became the center of the citrus growing industry.

Today, the UCR campus has grown to 1,110 acres. It is located three miles east of downtown Riverside in one of the fastest growing areas of California. This growth has brought an increasingly diverse and multi-cultural population to the region, with concomitant diversity in business and industry development in the surrounding communities. UCR serves as one of the most important educational and cultural resources for this area. Most academic activities occur within the 576.5 acre campus area east of I-215/SR-60 freeway, with the remaining 533.5 acres west of the freeway used for agricultural research and support programs.

UCR has experienced significant growth since the mid 1980's. Since the fall of 1984, student enrollment at UCR has grown from 4,805 to 15,720 students in the fall of 2003. Current projections indicate a significant additional increase to 25,000 students by the year 2015. This number of students will require major changes in teaching and research, development of services and programs for students, and the facilities to support these programs in a 21st century learning environment. UCR's academic programs are structured around three colleges and two professional schools: the College of Natural and Agricultural Sciences, the Bourns College of Engineering, the College of Humanities, Arts and Social Sciences, the A. Gary Anderson Graduate School of Management, the School of Education, and one division—Biomedical Science.

2.2 UCR Genomics Institute

The University of California is recognized worldwide as a leader in research and education that fuels innovation and economic growth. UC faculty and students conduct research that opens doors to technological advancements that improve social, environmental, and economic characteristics of California, and that build a strong foundation for the state's future.

UCR Genomics will concentrate on plant, pest and microbial genomics. The institute will focus on the development of new products such as medicinal plants, safer and more nutritious foods, stress-resistant crops, foods with a prolonged shelf life, disease-resistant animals, and novel bio-based products. Application of these emerging technologies will transform the way agricultural products are produced, transported, and stored, and will have far-reaching impacts on the health and well-being of the populace. Public education will be aimed at improving the health and diet of all Californians, while targeting the special needs of children, seniors, and the diverse population. In order to supply California with professionals capable of creating and disseminating the new knowledge necessary to maintain an edge in agricultural biotechnology, graduate education will be an essential component of the institute's efforts, as will undergraduate research training.

The UCR Genomics Building will provide specialized facilities for research in the following areas:

Insect Genomics

Insects are the most abundant terrestrial animals and have profound effects on human society. Research in insect genomics at UCR uses the tools of molecular biology and genomics to develop new non-traditional approaches for managing pest insects.

Plant Cell Biology/Genomics

Plants are the basis of all life on earth, whether as components of natural ecosystems or as domesticated crops used for food and materials. The challenges of this new century will extend from accurately assessing how plants react to stress in the environment to manipulating crop plants safely and efficiently for better and more sustainable production.

Microbial Genomics

Microorganisms are important for their roles in plant and animal pathogenesis, in global mineral cycling, in the degradation of pollutants, and as the foundation for biological food webs. The ability to examine these complex roles is now greatly enhanced by the availability of more than 50 complete microbial genome sequences and new tools to examine whole-genome expression patterns.

Mammalian Genomics

Human health and behavior are functions of our genome and the environment. The genome determines how we respond to the environment, and the environment affects the human genome in a dynamic way, turning genes on and off in response to extracellular signals. Research in cellular and molecular biology on mammalian and non-mammalian model organisms is the fastest moving area of biological sciences and is at the forefront of the genomics revolution.

Bioinformatics

Bioinformatics is an interdisciplinary field that provides much-needed support for research in genomics. Scientists in this area develop statistical and algorithmic approaches for the production and extraction of pertinent information from the large amounts of biological data made available by the new technologies of genomics.

Center for Plant Cell Biology

The newly initiated Center for Plant Cell Biology, part of the UCR Genomics Institute, will carry out cutting-edge research to answer the significant outstanding questions in plant biology by integrating genomic, bioinformatic, cellular, molecular, biochemical and genetic approaches. The center will synergize UCR's existing strengths in botany and plant sciences in part by providing an infrastructure that promotes interdisciplinary research and interaction among researchers.

Biotechnology Impacts Center

A distinctive aspect of UCR's efforts in genomics is the emphasis on the social, environmental, ethical and economic issues raised by the practical uses of biotechnology. The Biotechnology Impacts Center serves as an "honest broker" forum to identify the relevant policy issues, acts as a clearinghouse for credible information on those issues, and initiates research that addresses the potential benefits and consequences of the genomics revolution. The resulting knowledge will raise consumer awareness and inform public policy discussions among public interest groups, the biotechnology industry, academics, elected officials and policy makers.

2.3 Long Range Development Plan

The Long Range Development Plan (LRDP) is a comprehensive plan that guides the development of future facilities in the University of California system within a given campus. The draft 2003 LRDP for the University of California, Riverside, identifies the physical development needed to achieve the academic goals of the campus through the year 2015 for an anticipated student enrollment of 25,000. In addition, it describes the LRDP Vision and Goals:

The Vision For UC Riverside

- Create a state-of-the-art plan that conveys the university's excellence
- Develop land use elements to strengthen academic, cultural, and social interaction
- Preserve, enhance, and restore the natural environment
- Strengthen and clarify circulation systems
- Maintain planning flexibility



Open space



Utilities

Manifest the 2010 Vision for UCR

The four major themes that can inform physical planning for the campus are:

- World leadership in selected areas (including the environment, materials science, nanotechnology, genomics, the human condition, and Latin America)
- A culture of inquiry where all participants are engaged in the intellectual life of the university
- Diversity and excellence in students, faculty and staff
- Foster and encourage a moral imperative to engage the critical issues of society such as the environment and education

Sustainability Principles

Sustainable design and planning requires the cooperation and consideration of all sectors of the institution and requires a long-term, life-cycle perspective. Basic principles of sustainability that will inform future planning and design at UCR include:

- Preserving open space/conserving land resources
- Providing alternative transportation choices
- Minimizing site disturbance
- Protecting natural resources
- Reducing waste
- Reducing energy and water use
- Protecting the health and well-being of the campus and surrounding community
- Protecting the health and well-being of building occupants
- Educating the community in sustainable practices

The LRDP presents a detailed account of past planning, existing conditions and land uses, proposed land uses, and mitigation recommendations. The proposed site for the Genomics Building is located north of Entomology I, at the southeast corner of Eucalyptus and Citrus Drives. The site area is approximately 75,000 square feet (sf), or about 1.7 acres. There is a grade differential of approximately 20 feet from the high point at the southeast corner to the low point at the northwest corner. Citrus Drive is the west edge of the site, and Eucalyptus Drive is the north edge. A portion of the site is paved parking while lawn and the Entomology Annex greenhouse occupies the balance. This greenhouse is scheduled for removal in the summer of 2004.

2.4 Planning and Design Guidelines

In addition to the LRDP, the building and site designs must be responsive to the campus standards. These design and planning standards are set forth in the following documents:

- Campus Design Guidelines (1996)
- Campus Landscape Guidelines (1996)

2.5 Planning Process



The DPP process began in late January 2003. The Planning Committee, comprised of the CNAS Dean's office and faculty, the Office of Academic Planning and Budget, and the Office of Design and Construction, was established to provide input for and review of program and design concepts. Numerous research lab models were studied and compared to evaluate ideas of how research labs, lab support, and office spaces can be distributed and how relationships are affected. As the program developed, site and building design concepts were studied and presented to the Committee. Updates and presentations were made in a series of three, two-day workshops that culminated in the completion of the final DPP document in spring 2003. The program was further expanded in the fall of 2003, and those results are reflected in this document.



2.6 Key Program Assumptions

The project scope is determined by the available budget, with the major variables including building efficiency and cost per square foot. The result is approximately 63,986 assignable square feet (asf) at 58% efficiency, at a cost of \$339/sf, which includes building and site to midpoint of construction (types II and III equipment are not included).

Four additional sites were evaluated in the design process, and a summary critique of these sites and their location is in Appendix A.

2.7 Project Goals

In the process of developing a comprehensive program that will permit the Genomics Building to meet its research objectives, the following project objectives and goals apply:

- Create an environment that fosters intellectual stimulation and collaboration between faculty, post-doctoral and graduate students.
- Create a building that can adapt to technological and scientific advancements.
- Maximize the research space that provides the institute with a facility that supports the highest quality research.
- Create a building that establishes an identity for the institute, yet is fully integrated into the campus fabric, supporting campus planning guidelines and objectives.
- Develop a program that encourages synergies between the various research groups.
- Pursue opportunities that emphasize sustainable design solutions.

3.0 Program

3.1 Program Overview

A total of 63,986 asf has been programmed for the Genomics Building, and the projected total gross building area is 110,321 gsf at 58% efficiency.

3.2 Preliminary Planning Program

Research floor organization is based on the following principles:

Offices

- Proximity of Principal Investigator (PI) offices to labs is high priority, but offices need not be contiguous to labs
- Proximity of PI offices to graduate students/post-doctorals is more important than to other PI offices
- Combine office space for grad students and post docs to encourage interaction

Labs

- Optimize contiguous lab space for maximum flexibility
- Provide open lab configuration with capability for subdivision
- Assume two-thirds open labs and one-third enclosed labs
- Maintain flexibility in labs for alternate write up areas and optimization of bench space

Lab support

- Locate contiguous to labs
- Locate hoods in alcoves or support spaces adjacent to labs, not within the labs
- Provide chemical fume hood capacity of 1 to 1.5 per 3-module lab (6' length)

Bioinformatics

- Locate central to labs

The space requirements for the major program areas are summarized as follows.

Space Program Summary

Index	SPACE TYPE	QTY	ASF	Total ASF
RESEARCH LABORATORIES				
2.01	Research Labs - Open and Cellular(modules)	93	315	29,295
2.02	Bioinformatics	4	400	1,600
			Laboratory Subtotal	30,895
RESEARCH SUPPORT				
3.01	Equipment Room	6	315	1,890
3.02	Dark Room	1	105	105
3.03	Autoclave Glasswash	3	473	1,419
3.04	Radioisotope Room	7	158	1,106
3.05	Growth Chambers/Equipment Room	3	315	945
3.06	Insectaries	3	210	630
3.07	Arabidopsis Rooms	3	210	630
3.08	Cell Culture Room	14	210	2,940
3.09	Fume Hood Alcove/Chemical Storage	32	84	2,688
3.10	Cluster Farm (Bioinformatics)	1	500	500
3.11	Controlled Temperature Room (+4°C)	8	119	952
3.12	Cryo Storage	2	105	210
			Lab Support Subtotal	14,015
OFFICE/ADMIN/CONFERENCE				
4.01	Faculty Office (PI)	36	132	4,752
4.02	Post Docs	72	60	4,320
4.03	Grad Students	108	40	4,320
4.04	Administrative Support	6	120	720
4.05	Work Study Student	5	40	200
4.06	Faculty Colloquium	1	145	145
4.07	Copy/Mail/Workroom	1	269	269
4.08	Conference	4	264	1,056
4.10	Conference Facility (Dean's Office)	1	2,730	2,730
			Subtotal	18,512
BUILDING SUPPORT				
5.01	Loading Dock	1	300	300
5.02	Telecommunications Server	2	132	264
			Building Support Total	564
			PROGRAM TOTAL ASF	63,986
			Net/Gross Ratio	58.0%
			TOTAL BUILDING GSF	110,321

3.3 Service Yard Program

The service yard will be shared with Entomology I, and the following program describes the critical elements:

	Entomology I	Genomics
Loading		
Docks	2	2
On-Site Trucks	30' (45' Radius)	30' (45' Radius)
Street Loading	Yes > 30'L truck	Yes > 30'L truck
Dock Height	24"	24" Min.
Parking		
Service Vehicles	At Dock Only	At Dock Only
Electric Vehicles	No	No
E-Plate Vehicles	No	No
Handicapped	2 (To Be Relocated to Lot #7)	No (Located Elsewhere)
Other	No	No
Utilities/Services		
Emergency Generator	No (Below Grade S. Side)	Yes (Below Grade?)
Trash/Recycling	12'x18'	Share with Entomology
Compactor	No	No
Other		
Fenced Storage	35'x50' To Remain	No

3.4 Functional Relationships

There are two major entrances to the Genomics Building: one from the southeast corner of Eucalyptus and Citrus Drive, one from the visitor and staff parking adjacent to the pedestrian mall through the central courtyard. Both entries lead to the public area of the facility.

Public and Campus Facilities

Public spaces and building support services will be located on the first and second levels with direct adjacencies to the campus and visitor parking.

Research and Office Facilities

Genomics Research is composed of labs, lab support, faculty offices, post-doctoral and graduate student offices, and PI offices. These spaces will be located on the four upper floors of the building.

The research labs are divided into modules to promote maximum flexibility for lab sizes and for future adaptation. Lab support will be contiguous to the lab modules.

The faculty offices are clustered in close proximity to the labs. The graduate and post-doctoral students will be in shared offices adjacent to faculty offices. Office and office support spaces such as conference rooms, copy, mail and interactive areas will be clustered near faculty offices and be distributed throughout the building.

3.5 Lab Design Considerations

One of the primary goals was to design for lab and office flexibility. This was addressed in a number of ways, including the use of modular design for both. Modular design develops space sizes that are based on groupings, configurations, assignments, and future renovation. Modular planning is used as an organizational tool to allocate space within a building. The module establishes a grid by which walls and partitions are located. The research lab modules are 10'-6" x 30' (315 asf).

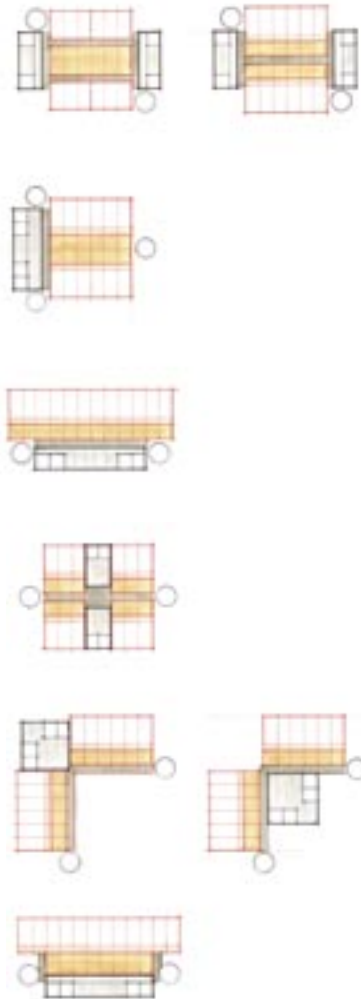

Lab/Office - Prototypes

Laboratories should be organized around modular planning principles so they are constructed with standardized units or dimensions for flexibility and a variety of uses. As modifications are required because of changes in laboratory use, instrumentation, or departmental organization, partitions can be relocated, doors moved, and laboratories expanded into larger laboratory units or contracted into smaller laboratory units without requiring reconstruction of structural or mechanical building elements.

The planning modules may be combined to produce large, open laboratories or subdivided to produce small instrument or special-use laboratories.

The above description of the planning module also includes the organized and systematic delivery of laboratory piped services, HVAC, fume hood exhaust ducts, power and signal cables. If these services are delivered to each laboratory unit in a consistent manner, then changes in laboratory use requiring addition or deletion of services will be easy to accomplish because of the constant nature of the infrastructure.

The proposed laboratory planning module for the Genomics Building was derived by analyzing the laboratory bench, equipment, and circulation space required for the occupying functions. The module is based on the bench space (width and length) required for technical workstations, instruments, and procedures. The space required between benches is designed to allow people to work back-to-back at adjacent benches, to allow for accessibility for disabled and still allow for movement of people and laboratory carts in the aisle.

A planning module approximately 10'-6" wide by 30'-0" deep is recommended for the laboratory spaces. By basing this module on a 10'-6" architectural grid so that alignment with exterior window mullions and structural columns is assured, each lab will have similar HVAC, power, data and finishes and is interchangeable to allow for maximum flexibility. By clustering labs and lab support, the opportunity exists to connect multiple labs to accommodate teams of researchers that may require more lab and lab support space. This module also provides adequate bench space plus space for floor-standing equipment and fume hoods, and can be divided for smaller support spaces such as equipment and instrument rooms.

Island and peninsula benches which are 5'-0" deep (with staggered knee spaces), and wall benches 2'-6" deep are recommended to accommodate the anticipated instruments.

A 5'-0" minimum aisle width between benches will reduce circulation conflicts and reduce potential safety hazards. It is critical in all laboratory spaces that carts are able to maneuver without conflict in aisles.

The proposed module width will accommodate the above requirements and will provide sufficient space in laboratories when movable computer stations or equipment racks are used near laboratory benches.

Effective circulation is an important element in the design of the Genomics building. Materials delivered to the facility will include chemicals, biological materials, supplies and equipment. In addition to material delivery, the debris and waste generated by lab activities must be safely removed.

Internal building circulation should provide safe pedestrian egress from each individual laboratory and laboratory support space through an uncomplicated path of egress to the building exterior at-grade. The circulation system must accommodate the preferred adjacencies identified for the relationships between public access spaces and non-public laboratories, support spaces, laboratories and offices.

Other features that should be considered in the design of the circulation system include:

- At least one door into each laboratory space should have a minimum 52" wide clear opening. This can be accomplished using openings with 3'-0" active leaf and one 1'-6" inactive leaf.
- Equipment lists should be carefully reviewed to verify that individual pieces of equipment can be transported and maneuvered between spaces. Future equipment should be anticipated.
- Interior circulation corridors should be a minimum of 6'-0" wide.
- Doorways accessing corridors should open into recessed alcoves serving the corridor. The doors should swing out from laboratories in the direction of exit.
- Circulation and fume hood locations should be coordinated to preclude exiting in front of the fume hoods.

Design that encourages interaction is fundamental to the Genomics building. There are three basic aspects of interaction:

- Within each laboratory group
- Inter-departmental
- Between institutions

This requires that spaces be created within laboratories, between laboratories, on each floor, and in public areas. These areas for formal and, in particular, informal interaction will be linked to the circulation schemes. Concepts should be developed as part of the design process that will directly support these objectives.

Formal Interaction Considerations

- Conference rooms

Plan Configurations

- Smaller spaces should be located close to laboratories—larger spaces can be remote.
- Side-by-side connections of laboratories, cross corridor laboratory connection, and through laboratory support space connections.
- Shared support spaces (equipment and instrument rooms) close to laboratories.
- Link between outdoor gathering spaces and interior interaction spaces.
- Inviting and visible horizontal and vertical circulation systems can also serve as interaction spaces. Circulation systems encourage sharing of support functions.

Providing accessibility for persons with disabilities requires special design considerations. The facility must conform to applicable local, state and federal regulations. UCR requires that 5% of the labs be accessible. Early consideration should be given to the following accessibility aspects:

- Accessible workstations and fume hoods should be provided in the laboratories based on code requirements.
- Location of accessible work stations as close as possible to eyewash and safety showers.
- An 18" clearance on the pull side and 12" clearance on the push side of doors opposite the hinged side is required.

Some general criteria and guidelines for accessible work stations in laboratories are as follows:

- Work surfaces 30" to 34" above floor with wheelchair clearance below. Adjustable work surfaces can provide a range of possible height adjustments.
- Laboratory service controls, equipment, and equipment controls within easy reach for persons with limited mobility. Controls should have single-action levers or blade handles for easy operation.
- Aisle widths and clearances adequate for maneuvers of wheelchair bound individuals. Aisles 5'-0" wide with turnaround areas are recommended.

Noise control requires specific attention to design and construction details. The following features should be addressed in the design of the mechanical and electrical systems:

- Noise levels in the labs must be kept below 55 decibels (dB) in order to facilitate easy verbal communication.
- Fan noise transmitted to spaces through the duct system or through the building structure. This noise is characterized by a low-frequency rumble and often includes annoying pure tones.
- Noise generated by the excitation of duct wall resonance produced by fan noise, by pressure fluctuations caused by fan instability, and by high turbulence caused by discontinuance in the duct system.
- Noise generated by air flowing past dampers, turning vanes, terminal device louvers, and comprising mid- to high-frequency energy.
- Water circulation system noise caused by high velocities or abrupt pressure changes, which is generally transmitted through structural connections.
- Noise and vibration caused by out-of-balance forces generated by the operation of fans, pumps, compressors, etc.
- Magnetostrictive hum associated with the operation of fluorescent lighting ballasts, transformers, or electric motors.
- Elevator equipment noise from motor generators, hoist gear, and counter-weight movement, or from hydraulic pump systems.

Other design precautions include:

- Conduits should not directly link noise-sensitive spaces, nor should they mechanically bridge vibrationally-isolated building elements using a rigid connection.
- Flexible conduit must be used for connections to isolated floor slabs, walls, and vibrationally isolated mechanical/electrical devices.
- Duct silencers will be considered when duct distance is not sufficient to provide adequate acoustical separation. The nature of research activity being conducted requires structural dynamics consideration.
- Footfall-induced vibrations on above-grade floors should be reduced by:
 - confining heavily traveled areas to regions near column lines
 - placing sensitive equipment near columns
 - placing the equipment away from heavily traveled areas
 - minimizing the length of spans

Increasing the stiffness of the floor slab alleviates vibration. Providing a combination of mass and/or depth for above-grade slabs increases the stiffness. Cast-in-place concrete has natural characteristics and mass advantages for vibration reduction.

Air handling equipment and ductwork shall be designed to minimize vibration. Supply and exhaust air fans, compressors, pumps, and other noise and vibration-producing equipment should be located in mechanical rooms with protective wall construction. Equipment should be isolated from supporting structure with resilient mounts. Vibration isolators should be selected based on floor stiffness, span extension, equipment power and operating speed.

Instruments that are extremely sensitive to vibration (scanning electron microscope or transmission electron microscope, NMR, etc.) should be located on slab-on-grade construction to minimize transient structure-borne vibration. Pneumatic and piezoelectric isolations should be used, as required, on specified highly-sensitive equipment.

Vibration criteria for areas intended to accommodate sensitive equipment are based on rms Velocity Level as measured in one-third octave bands of frequency over the range of 8-100 Hz. Generic Vibration Criterion (VC) curves have been developed for different types of equipment.

3.6 Room Data Sheets and Diagrams

The Room Data Sheets represent the criteria for support services and finishes required for each room type.

ARCHITECTURAL

Floor Finishes

VCT	Vinyl Composition Tile
SV	Sheet Vinyl
CPT	Carpet/ Static control
ST	Stone
SL	Sheet Linoleum
RF	5" Raised Flooring
RB	Rubber Base
CT	Ceramic Tile

Doors

Wall Finishes

GYP	Gypsum Board
GYP/SI	Gypsum Board w/ Sound Insulation
P	Paint
EP	Epoxy Paint
WD	Wood Paneling
VP	Veneer Plaster
GYP/AWT	Gypsum Board w/ Acoustic Wall Treatment
CT	Ceramic Tile
FAB	Fabric Wall Covering

Ceiling Finishes

AP	Acoustic Panel
GYP	Gypsum Board
WD	Wood Panels

Doors

D1	3'-0" Stain Grade Wood Door
D2	3'-0" Metal Door with vision panel and 1'-6" Operable Leaf
D3	3'-0" Stain Grade Wood Door with vision panel

Window Coverings

WC1	Horizontal Blinds
WC2	Blackout Drapes
WC3	Roller Blinds, Mechanical operations w/ blackout capability

ELECTRICAL

Lighting

T1	Fluorescent, 2X4, direct and indirect, multiple controls
T2	Fluorescent, 2X4, w/ Parabolic lens, multiple controls
T3	Compact Fluorescent, Recessed Can Lights
T4	T1 & T3 Zoned and Dimmable, multiple controls
T5	Specialty lighting
FC	Foot candles

Data

F	Fiber pulled and terminated
C	Copper conduit for Ethernet (Category 6) wireless system OF/CI

Security

CK1	Card Key at Door, OF/CI
CK2	Card Key at Suite entry, OF/CI
CK3	Locking Door Assembly
DO	Duplex Outlets 110/120V
SO	Service Outlets 208 or 240V

Surveillance and security systems are OF/CI

MECHANICAL

Emergency Power, cooling systems for certain spaces is to be on emergency backup power- refer to mechanical narrative in the appendix for more detail.

SPECIALTIES

Tack and Marker Boards

S1	4'X6' White Board
S2	4'X8' White Board
S3	4'X6' Tack Board
S4	4'X6' Literature Rack
S5	Wall brackets with 30" wide adjustable shelves or wall mounted bookshelves OF/CI Provide structural bracing in walls, CF/CI
S6	Built-in casework, counter with lockable upper and lower cabinets. Plastic laminate. Same as S6 with sink
S7	8'X12' Electronic projection screen, Recessed in ceiling
S8	8'X16' Electric projection screen, Recessed in ceiling
S9	Continuous work surface with modesty panel, and over and data outlets at each student station
S10	Built-in Casework, Wood Panel Storage Wall and coat closet
S11	Moveable wall system, high acoustic insulation and sound gaskets
S12	Donor Wall, Wood
S13	Directory, Wood
S14	Chair Rails
S15	

Miscellaneous

Unless otherwise indicated all room criteria is contractor furnished and contractor installed. CF/CI

DEPARTMENT: GENOMICS
SPACE NAME: FACULTY OFFICE
INDEX NO.: 4.01
OCCUPANCY: 1

ARCHITECTURAL

Floor CPT
 Base RB
 Wall material GYP/SI
 Wall finish P
 Ceiling ht. 9'
 Ceiling material AP
 Ceiling finish _____
 Doors D1
 Windows Yes
 Relites _____
 Window covering WC1

EQUIPMENT

P.C. 1 OF/OI
 Printer 1 OF/OI
 Scanner _____
 Copier _____
 Plotter _____
 Vending Mach. _____
 Microwave _____
 Refrigerator _____
 Coffee _____
 Dishwasher _____
 Other _____

ELECTRICAL

Lighting type T1
 Lighting level 50 FC
 Duplex outlets 6
 Service outlets _____
 Data outlet _____
 Fiber 1
 Ethernet/copper 3
 Wireless system Yes
 Portable equip. outlets _____
 Dedicated power _____
 Surge protection _____
 Emergency power _____
 Clock _____
 Security system CK2,CK3
 Surveillance system _____
 Other _____

MECHANICAL

Heating Yes
 Cooling Yes
 Humidity control _____
 Exhaust _____
 Other _____

COMMUNICATIONS

Telephone 1
 Intercom _____
 Fax _____
 Teleconferencing _____
 Sound enhancement (TDD) _____

SPECIALTIES

Coat closet _____
 Tackboard _____
 Markerboard 1 S1
 Chalkboard _____
 Literature rack _____
 Display rail _____
 Projection screen _____
 Built-in casework S5
 Other _____

AV EQUIPMENT

Projector _____
 Ceiling mounted _____
 LCD connection _____
 Public address system _____
 Camera _____
 Monitors _____
 Podium _____
 Podium controls _____
 LCD connection _____
 Power _____
 Data _____
 Phone _____
 Light _____
 Projection screen _____

OTHER NEEDS

DEPARTMENT: GENOMICS
SPACE NAME: FACULTY OFFICE

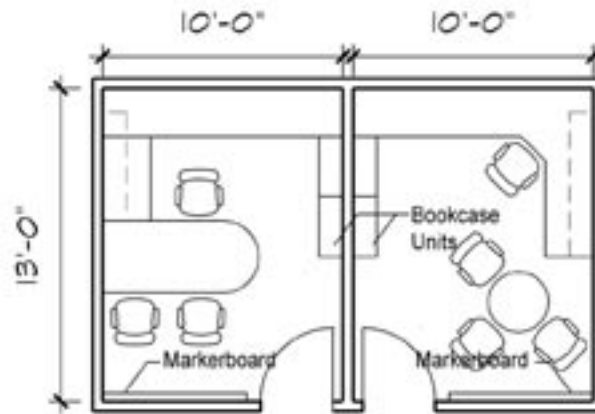

DEPARTMENT: GENOMICS
SPACE NAME: POST DOC OFFICE
INDEX NO.: 4.02
OCCUPANCY: 1

ARCHITECTURAL

Floor CPT
 Base RB
 Wall material GYP/SI
 Wall finish P
 Ceiling ht. 9'
 Ceiling material AP
 Ceiling finish
 Doors
 Windows
 Relites
 Window covering

EQUIPMENT

P.C. 1 OF/OI
 Printer 1 OF/OI
 Scanner
 Copier
 Plotter
 Vending Mach.
 Microwave
 Refrigerator
 Coffee
 Dishwasher
 Other

ELECTRICAL

Lighting type T1
 Lighting level 50 FC
 Duplex outlets 2
 Service outlets
 Data outlet
 Fiber 1
 Ethernet/copper 1
 Wireless system Yes
 Portable equip. outlets
 Dedicated power
 Surge protection
 Emergency power
 Clock
 Security system CK2,CK3
 Surveillance system
 Other

MECHANICAL

Heating Yes
 Cooling Yes
 Humidity control
 Exhaust
 Other

COMMUNICATIONS

Telephone 1
 Intercom
 Fax
 Teleconferencing
 Sound enhancement (TDD)

SPECIALTIES

Coat closet
 Tackboard
 Markerboard
 Chalkboard
 Literature rack
 Display rail
 Projection screen
 Built-in casework
 Other

AV EQUIPMENT

Projector
 Ceiling mounted
 LCD connection
 Public address system
 Camera
 Monitors
 Podium
 Podium controls
 LCD connection
 Power
 Data
 Phone
 Light
 Projection screen

OTHER NEEDS

Modular furniture in open office plan

DEPARTMENT: GENOMICS
SPACE NAME: POST DOC OFFICE

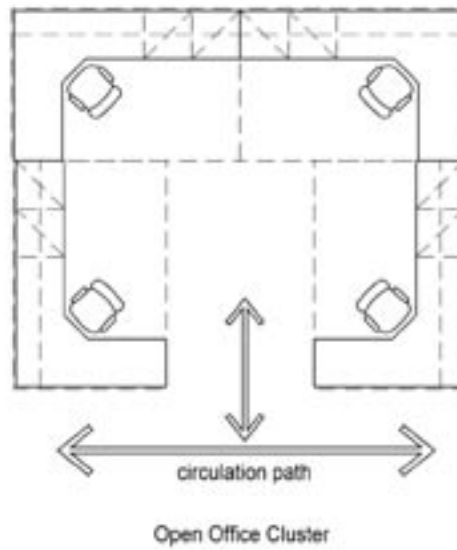
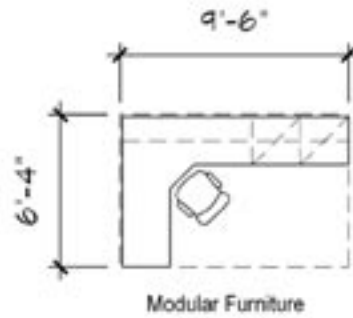

DEPARTMENT: GENOMICS
SPACE NAME: GRAD STUDENT OFFICE
INDEX NO.: 4.03
OCCUPANCY: 1

ARCHITECTURAL

Floor CPT
 Base RB
 Wall material GYP/SI
 Wall finish P
 Ceiling ht. 9'
 Ceiling material AP
 Ceiling finish
 Doors
 Windows
 Relites
 Window covering

EQUIPMENT

P.C. 1 OF/OI
 Printer 1 OF/OI
 Scanner
 Copier
 Plotter
 Vending Mach.
 Microwave
 Refrigerator
 Coffee
 Dishwasher
 Other

ELECTRICAL

Lighting type T1
 Lighting level 50 FC
 Duplex outlets 2
 Service outlets
 Data outlet
 Fiber 1
 Ethernet/copper 1
 Wireless system Yes
 Portable equip. outlets
 Dedicated power
 Surge protection
 Emergency power
 Clock
 Security system CK2,CK3
 Surveillance system
 Other

MECHANICAL

Heating Yes
 Cooling Yes
 Humidity control
 Exhaust
 Other

COMMUNICATIONS

Telephone 1
 Intercom
 Fax
 Teleconferencing
 Sound enhancement (TDD)

SPECIALTIES

Coat closet
 Tackboard
 Markerboard
 Chalkboard
 Literature rack
 Display rail
 Projection screen
 Built-in casework
 Other

AV EQUIPMENT

Projector
 Ceiling mounted
 LCD connection
 Public address system
 Camera
 Monitors
 Podium
 Podium controls
 LCD connection
 Power
 Data
 Phone
 Light
 Projection screen

OTHER NEEDS

Modular furniture in open office plan

DEPARTMENT: GENOMICS
SPACE NAME: GRAD STUDENT OFFICE

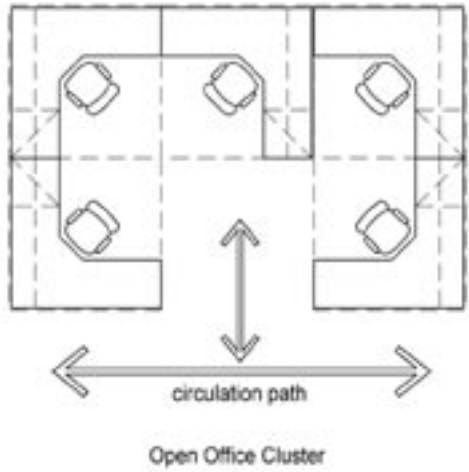
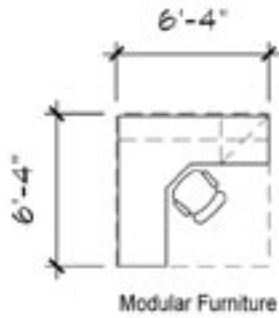

DEPARTMENT: GENOMICS
SPACE NAME: ADMIN. SUPPORT SPACE
INDEX NO.: 4.04
OCCUPANCY: 1

ARCHITECTURAL

Floor CPT
 Base RB
 Wall material GYP/SI
 Wall finish P
 Ceiling ht. 9'
 Ceiling material AP
 Ceiling finish
 Doors
 Windows
 Relites
 Window covering

EQUIPMENT

P.C. 1 OF/OI
 Printer 1 OF/OI
 Scanner
 Copier
 Plotter
 Vending Mach.
 Microwave
 Refrigerator
 Coffee
 Dishwasher
 Other Fax OF/OI

ELECTRICAL

Lighting type T1
 Lighting level 50 FC
 Duplex outlets 2
 Service outlets
 Data outlet
 Fiber 1
 Ethernet/copper 1
 Wireless system Yes
 Portable equip. outlets
 Dedicated power
 Surge protection
 Emergency power
 Clock
 Security system CK2
 Surveillance system Yes
 Other

MECHANICAL

Heating Yes
 Cooling Yes
 Humidity control
 Exhaust
 Other

COMMUNICATIONS

Telephone 1
 Intercom
 Fax 1 NET OF/OI
 Teleconferencing
 Sound enhancement (TDD)

SPECIALTIES

Coat closet
 Tackboard
 Markerboard
 Chalkboard
 Literature rack
 Display rail
 Projection screen
 Built-in casework
 Other

AV EQUIPMENT

Projector
 Ceiling mounted
 LCD connection
 Public address system
 Camera
 Monitors
 Podium
 Podium controls
 LCD connection
 Power
 Data
 Phone
 Light
 Projection screen

OTHER NEEDS

Modular furniture in open office plan

DEPARTMENT: GENOMICS

SPACE NAME: ADMIN. SUPPORT SPACE

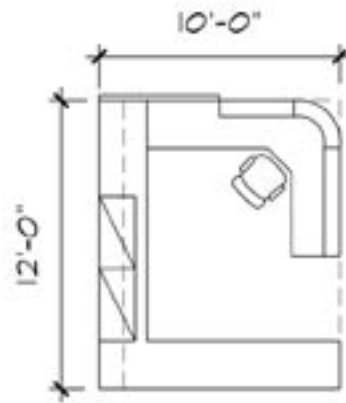

DEPARTMENT: GENOMICS
SPACE NAME: COPY, MAIL, WORKROOM
INDEX NO.: 4.07
OCCUPANCY: 3 TO 6

ARCHITECTURAL

Floor VCT
 Base RB
 Wall material GYP/SI
 Wall finish P
 Ceiling ht. 9'
 Ceiling material AP
 Ceiling finish _____
 Doors WD
 Windows Not required
 Relites Yes
 Window covering WC1

EQUIPMENT

P.C. 1 OF/OI
 Printer 2 OF/OI
 Scanner 1 OF/OI
 Copier 1 OF/OI
 Plotter _____
 Vending Mach. _____
 Microwave _____
 Refrigerator _____
 Coffee _____
 Dishwasher _____
 Other _____

ELECTRICAL

Lighting type T3
 Lighting level 50 FC
 Duplex outlets 8
 Service outlets 2
 Data outlet _____
 Fiber 2
 Ethernet/copper 3
 Wireless system Yes OF/OI
 Portable equip. outlets _____
 Dedicated power _____
 Surge protection _____
 Emergency power _____
 Clock _____
 Security system CK1
 Surveillance system Yes
 Other _____

MECHANICAL

Heating Yes
 Cooling Yes
 Humidity control _____
 Exhaust _____
 Other _____

COMMUNICATIONS

Telephone 1
 Intercom _____
 Fax 1 network OF/OI
 Teleconferencing _____
 Sound enhancement (TDD) _____

SPECIALTIES

Coat closet _____
 Tackboard 1 S3
 Markerboard 1 S1
 Chalkboard _____
 Literature rack _____
 Display rail _____
 Projection screen _____
 Built-in casework S6
 Other S16

AV EQUIPMENT

Projector _____
 Ceiling mounted _____
 LCD connection _____
 Public address system _____
 Camera _____
 Monitors _____
 Podium _____
 Podium controls _____
 LCD connection _____
 Power _____
 Data _____
 Phone _____
 Light _____
 Projection screen _____

OTHER NEEDS

DEPARTMENT: GENOMICS

SPACE NAME: COPY, MAIL, WORKROOM

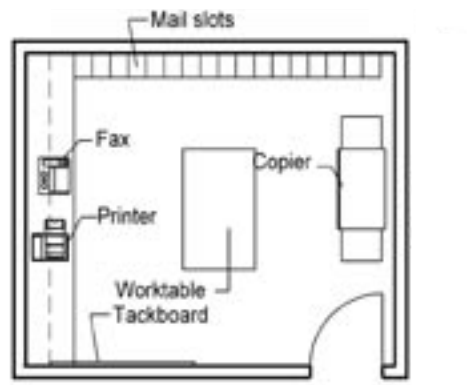

DEPARTMENT: GENOMICS
SPACE NAME: CONFERENCE ROOM
INDEX NO.: 4.08
OCCUPANCY: 6 TO 16

ARCHITECTURAL

Floor CPT
 Base RB
 Wall material GYP/SI
 Wall finish P
 Ceiling ht. 9'
 Ceiling material AP
 Ceiling finish
 Doors D1
 Windows Yes
 Relites Yes
 Window covering WC1, WC2

EQUIPMENT

P.C.
 Printer
 Scanner
 Copier
 Plotter
 Vending Mach.
 Microwave
 Refrigerator
 Coffee
 Dishwasher
 Other

ELECTRICAL

Lighting type T4
 Lighting level 50 FC
 Duplex outlets 6
 Service outlets
 Data outlet
 Fiber 1
 Ethernet/copper 2
 Wireless system Yes
 Portable equip. outlets
 Dedicated power
 Surge protection
 Emergency power
 Clock Yes
 Security system CK1
 Surveillance system
 Other

MECHANICAL

Heating Yes
 Cooling Yes
 Humidity control
 Exhaust
 Other

COMMUNICATIONS

Telephone 1
 Intercom
 Fax
 Teleconferencing
 Sound enhancement (TDD)

SPECIALTIES

Coat closet
 Tackboard
 Markerboard 2 S2
 Chalkboard
 Literature rack
 Display rail Yes
 Projection screen 1 S8
 Built-in casework
 Other

AV EQUIPMENT

Projector
 Ceiling mounted 1 OF/CI
 LCD connection 1 OF/CI
 Public address system
 Camera
 Monitors
 Podium
 Podium controls at head wall
 LCD connection
 Power
 Data
 Phone
 Light
 Projection screen Yes

OTHER NEEDS

DEPARTMENT: GENOMICS
SPACE NAME: CONFERENCE ROOM

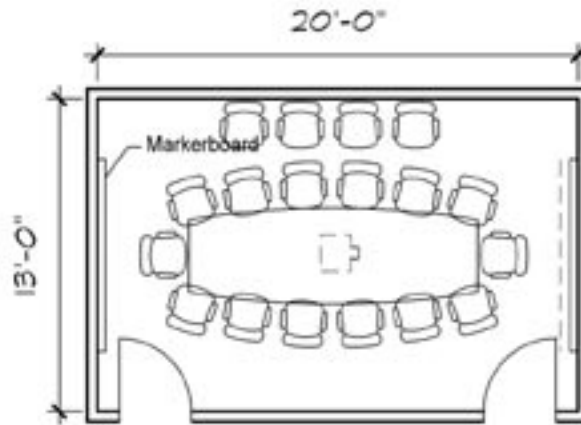

DEPARTMENT: GENOMICS
SPACE NAME: CONFERENCE FACILITY
INDEX NO.: 4.10
OCCUPANCY: 64 TO 100

ARCHITECTURAL

Floor CPT
 Base RB
 Wall material GYP/SI, S12
 Wall finish P, WD, FAB
 Ceiling ht. 10' MIN.
 Ceiling material AP, GYP, WD
 Ceiling finish P
 Doors D3
 Windows not req'd.
 Relites not req'd.
 Window covering WC3

EQUIPMENT

P.C. _____
 Printer _____
 Scanner _____
 Copier _____
 Plotter _____
 Vending Mach. _____
 Microwave _____
 Refrigerator _____
 Coffee _____
 Dishwasher _____
 Other _____

ELECTRICAL

Lighting type T4
 Lighting level 50 FC
 Duplex outlets 16
 Service outlets _____
 Data outlet _____
 Fiber 2
 Ethernet/copper 16
 Wireless system Yes
 Portable equip. outlets _____
 Dedicated power _____
 Surge protection _____
 Emergency power _____
 Clock _____
 Security system CK2
 Surveillance system Yes
 Other _____

MECHANICAL

Heating Yes
 Cooling Yes
 Humidity control _____
 Exhaust _____
 Other _____

COMMUNICATIONS

Telephone 2
 Intercom _____
 Fax _____
 Teleconferencing _____
 Sound enhancement (TDD) Yes

SPECIALTIES

Coat closet S11
 Tackboard _____
 Markerboard 6 S2
 Chalkboard _____
 Literature rack _____
 Display rail _____
 Projection screen 2 S9
 Built-in casework _____
 Other S15

AV EQUIPMENT

Projector _____
 Ceiling mounted 2 OF/CI
 LCD connection 2 OF/CI
 Public address system _____
 Camera _____
 Monitors _____
 Podium 2 OF/CI
 Podium controls at head wall
 LCD connection Yes OF/CI
 Power Yes
 Data Yes
 Phone Yes
 Light Yes
 Projection screen Yes

OTHER NEEDS

tiered floor, fixed tables, movable chairs

DEPARTMENT: GENOMICS
SPACE NAME: CONFERENCE FACILITY

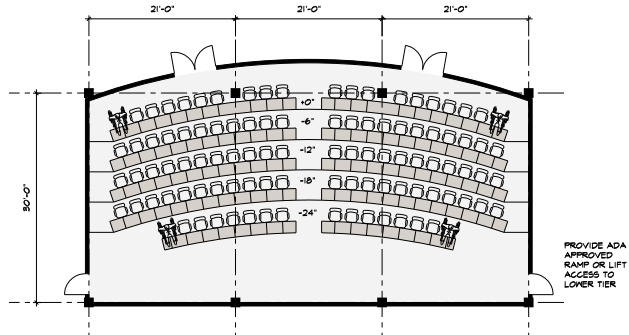

A 102 seats, 2050 s.f.
 tiered floor, tables, movable seats,
 fits under lab structure

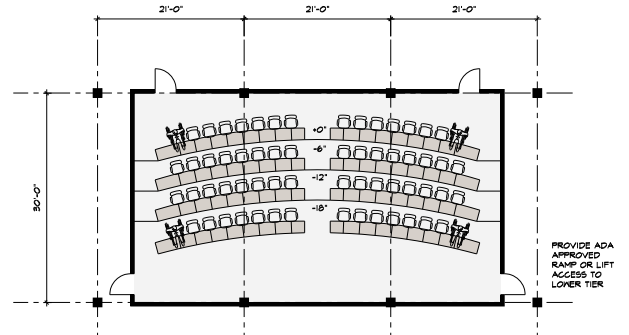

B 64 seats, 1575 s.f.
 tiered floor, tables, movable seats,
 fits under lab structure

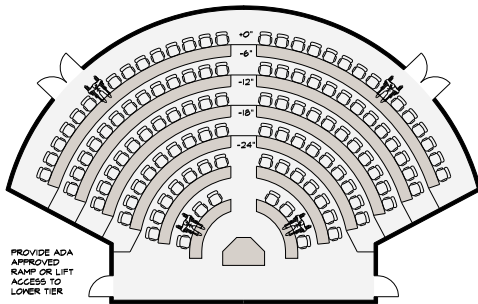

C 120 seats, 2000 s.f.
 tiered floor, tables, movable seats,
 long span structure required

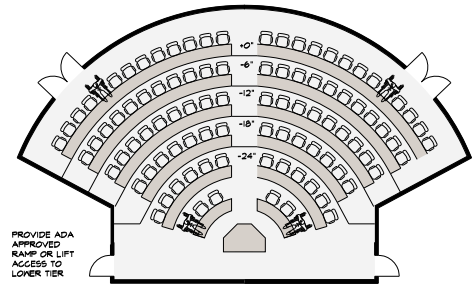

D 100 seats, 1730 s.f.
 tiered floor, tables, movable seats,
 long span structure required
 Program 1000 ASF for pre-
 function space

Programmed

DEPARTMENT: GENOMICS
SPACE NAME: TELECOM SERVER
INDEX NO.:
OCCUPANCY: 1

ARCHITECTURAL

Floor RF
 Base RB
 Wall material GYP/SI
 Wall finish P
 Ceiling ht. 9'
 Ceiling material AP
 Ceiling finish _____
 Doors D2
 Windows _____
 Relites _____
 Window covering _____

EQUIPMENT

P.C. T.B.D. OF/OI
 Printer 1 OF/OI
 Scanner _____
 Copier _____
 Plotter _____
 Vending Mach. _____
 Microwave _____
 Refrigerator _____
 Coffee _____
 Dishwasher _____
 Other Fax OF/OI

ELECTRICAL

Lighting type T1
 Lighting level 50 FC
 Duplex outlets Yes
 Service outlets _____
 Data outlet _____
 Fiber Yes
 Ethernet/copper Yes
 Wireless system Yes
 Portable equip. outlets _____
 Dedicated power Yes
 Surge protection _____
 Emergency power _____
 Clock _____
 Security system CK1
 Surveillance system _____
 Other _____

MECHANICAL

Heating Yes
 Cooling Yes
 Humidity control Yes
 Exhaust _____
 Other _____

COMMUNICATIONS

Telephone 2
 Intercom _____
 Fax _____
 Teleconferencing _____
 Sound enhancement (TDD) _____

SPECIALTIES

Coat closet _____
 Tackboard _____
 Markerboard _____
 Chalkboard _____
 Literature rack _____
 Display rail _____
 Projection screen _____
 Built-in casework _____
 Other _____

AV EQUIPMENT

Projector _____
 Ceiling mounted _____
 LCD connection _____
 Public address system _____
 Camera _____
 Monitors _____
 Podium _____
 Podium controls _____
 LCD connection _____
 Power _____
 Data _____
 Phone _____
 Light _____
 Projection screen _____

OTHER NEEDS

This page intentionally left blank.

DEPARTMENT: GENOMICS
SPACE NAME: TOILET ROOM
INDEX NO.:
OCCUPANCY: VARIES

ARCHITECTURAL

Floor CT
 Base CT
 Wall material GYP/CT
 Wall finish EP
 Ceiling ht. 9'
 Ceiling material GYP.
 Ceiling finish EP
 Doors D1
 Windows _____
 Relites _____
 Window covering _____

EQUIPMENT

P.C. _____
 Printer _____
 Scanner _____
 Copier _____
 Plotter _____
 Vending Mach. _____
 Microwave _____
 Refrigerator _____
 Coffee _____
 Dishwasher _____
 Other _____

ELECTRICAL

Lighting type T2
 Lighting level 50 FC
 Duplex outlets 6
 Service outlets _____
 Data outlet _____
 Fiber _____
 Ethernet/copper _____
 Wireless system _____
 Portable equip. outlets _____
 Dedicated power _____
 Surge protection _____
 Emergency power _____
 Clock _____
 Security system CK1
 Surveillance system _____
 Other _____

MECHANICAL

Heating Yes
 Cooling Yes
 Humidity control _____
 Exhaust _____
 Other _____

COMMUNICATIONS

Telephone _____
 Intercom _____
 Fax _____
 Teleconferencing _____
 Sound enhancement (TDD) _____

SPECIALTIES

Coat closet _____
 Tackboard _____
 Markerboard _____
 Chalkboard _____
 Literature rack _____
 Display rail _____
 Projection screen _____
 Built-in casework _____
 Other _____

AV EQUIPMENT

Projector
 Ceiling mounted _____
 LCD connection _____
 Public address system _____
 Camera _____
 Monitors _____
 Podium _____
 Podium controls
 LCD connection _____
 Power _____
 Data _____
 Phone _____
 Light _____
 Projection screen _____

OTHER NEEDS

Drinking fountains at toilet room
 entry vestibule

This page intentionally left blank.

DEPARTMENT: GENOMICS
SPACE NAME: LOADING DOCK
INDEX NO.:
OCCUPANCY: 2

ARCHITECTURAL

Floor CONC
 Base RB
 Wall material GYP
 Wall finish P
 Ceiling ht. 10'
 Ceiling material AP
 Ceiling finish _____
 Doors HM
 Windows _____
 Relites _____
 Window covering _____

EQUIPMENT

P.C. _____
 Printer _____
 Scanner _____
 Copier _____
 Plotter _____
 Vending Mach. _____
 Microwave _____
 Refrigerator _____
 Coffee _____
 Dishwasher _____
 Other _____

ELECTRICAL

Lighting type T2
 Lighting level 50 FC
 Duplex outlets 3
 Service outlets _____
 Data outlet _____
 Fiber _____
 Ethernet/copper _____
 Wireless system _____
 Portable equip. outlets _____
 Dedicated power _____
 Surge protection _____
 Emergency power _____
 Clock _____
 Security system CK1
 Surveillance system _____
 Other _____

MECHANICAL

Heating Yes
 Cooling Yes
 Humidity control _____
 Exhaust _____
 Other _____

COMMUNICATIONS

Telephone 1
 Intercom _____
 Fax _____
 Teleconferencing _____
 Sound enhancement (TDD) _____

SPECIALTIES

Coat closet _____
 Tackboard _____
 Markerboard _____
 Chalkboard _____
 Literature rack _____
 Display rail _____
 Projection screen _____
 Built-in casework _____
 Other _____

AV EQUIPMENT

Projector
 Ceiling mounted _____
 LCD connection _____
 Public address system _____
 Camera _____
 Monitors _____
 Podium _____
 Podium controls
 LCD connection _____
 Power _____
 Data _____
 Phone _____
 Light _____
 Projection screen _____

OTHER NEEDS

This page intentionally left blank.

DEPARTMENT: GENOMICS
SPACE NAME: RESEARCH LABORATORY - OPEN
INDEX NO.: 2.01
OCCUPANCY:



UTILIZATION

Hours of Use
 8 hours/day _____
 14 hours/day _____
 24 hours/day _____
 Hours of Operation
 8 hours/day _____
 14 hours/day _____
 24 hours/day _____

SECURITY

No Lock _____
 Keyed Lock _____
 Cardkey _____

MECHANICAL

Temperature
 72°F ± 2°F _____
 68°-75° ± 2°F _____
 Other _____
 Humidity
 50% ± 20% _____
 Ambient _____

15 Air Changes/Hour _____
 8 to 10 Air Changes/Hour _____
 6 Air Changes/Hour _____
 100% Make-up Air _____
 Recirculated Air _____
 Air Pressure Positive _____
 Air Pressure Negative _____
 Air Filtration/Supply _____

HOODS

Chemical Fume Hood Note 1. _____
 Radioisotope Hood _____
 Laminar Flow Hood _____
 Biological Safety Cabinet (OFOI) _____
 Snorkel _____
 Canopy Hood _____
 Other _____

LABORATORY EQUIPMENT

Vibration Sensitive _____
 Light Sensitive _____
 Vibration Producing _____
 Heat Producing _____
 Noise Producing _____

PLUMBING

Laboratory Gas (LG) _____
 Laboratory Vacuum (LV) _____
 Laboratory Air (LA) _____
 Compressed Air, 100 psi (A) _____
 Industrial Hot Water (IHW) _____
 Industrial Cold Water (ICW) _____
 Potable Cold Water _____
 Potable Hot Water _____
 High Purity Water (DI) _____
 Chilled Water (CHW S/R) _____
 Carbon Dioxide (CO₂) _____
 Nitrogen Gas (N₂) _____
 Cylinder Gases
 Inert _____
 Flammable _____
 Toxic _____
 Floor Drain (FD) _____
 Floor Sink (FS) _____
 Sediment Trap _____
 Safety Shower/Eyewash (SS) _____
 Drench Hose (DH) _____

ELECTRICAL

110V, 20A, 1 Phase _____
 208V, 30A, 1 Phase _____
 208V, 30A, 3 Phase _____
 480V, 100A, 3 Phase _____
 Isolated Ground Outlet _____
 Emergency Power _____
 UPS (OFOI) _____
 Voice / Data _____
 In Use Light _____
 Task Lighting _____
 Lighting Level
 50-60 fc direct/indirect _____
 75 fc at bench/desk _____
 Safe light _____
 Special Lighting _____
 Darkenable _____
 Zoned Lighting _____

CHEMICALS

Bases _____
 Acids _____
 Solvents _____
 Radioisotopes _____
 Carcinogens/Regulated _____
 Chemical Waste Storage _____
 Biological Storage _____
 Radioisotope Storage _____
 Chemical Storage _____

ARCHITECTURAL

Floor
 VCT (Chemical Resistant) _____
 VCT _____
 Welded Seam Sheet Vinyl _____
 Epoxy _____
 Carpet _____
 Low Static Carpet _____
 Sealed Concrete _____
 Partitions
 Gyp Board, Epoxy Paint _____
 Gyp Board, Paint _____
 Other _____
 Base
 4" Rubber _____
 Integral w/floor _____
 Ceiling
 Open _____
 Acoustic Tile _____
 Gyp Board, Epoxy Paint _____
 Height 9' min. _____
 Doors
 3'-6" x 7' _____
 3' x 7' _____
 1'-6" x 7' _____
 Light Tight Rotating Door _____
 Vision Panel _____
 Natural Daylight _____
ACOUSTICS
 Normal _____
 Privacy _____

REMARKS:

1. In adjacent alcove - Allow (1) 6' CFH per two modules
2. Epoxy resin tops @ research benching
3. Plam bench tops at write-up benches
4. Maple casework with clear finish
5. Epoxy resin drop-in sinks

OWNER FURNISHED EQUIPMENT:

- a. Refrigerator
- b. PC's
- c.
- d.
- e.

DEPARTMENT: GENOMICS
SPACE NAME: RESEARCH LABORATORY OPTION "A"
INDEX NO.: 2.01
AREA: 315 ASF/MODULE



This diagram is conceptual and is provided only to indicate required furnishings, equipment, and general room proportions. The actual room design may change.

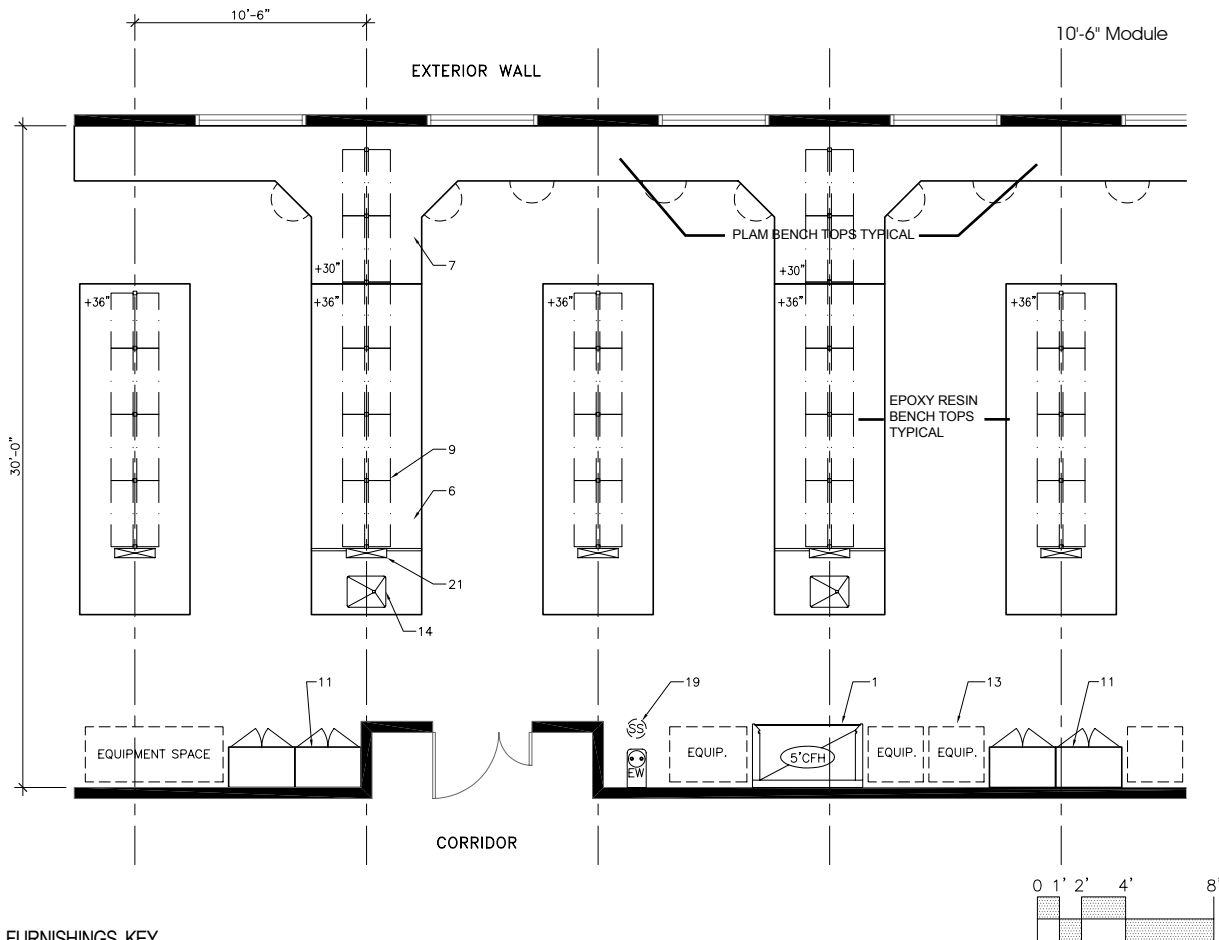

FURNISHINGS KEY

- | | | |
|--------------------------------------|----------------------------------|---|
| 1. Chemical Fume Hood | 13. Equipment Space | 25. Autoclave |
| 2. Biological Safety Cabinet | 14. Laboratory Sink | 26. Moveable Laboratory Table |
| 3. Radioisotope Hood | 15. Cupsink | 27. Wire Shelving |
| 4. Laminar Flow Hood | 16. Processing Sink | 28. Heavy Duty Shelving Unit |
| 5. Snorkel Exhaust | 17. Cylinder Rack | 29. White Markerboard |
| 6. Laboratory Bench, Standing Height | 18. Gas Cabinet | 30. Tackboard |
| 7. Laboratory Bench, Sitting Height | 19. Safety Shower/Eyewash | 31. Tech Desk |
| 8. Wall Cabinet | 20. Overhead Service Carrier | 32. Balance Table |
| 9. Adjustable Shelves | 21. Pipe Drop Enclosure | 33. Writing Table |
| 10. Reagent Shelves | 22. Moveable Demonstration Bench | 34. AV Screen |
| 11. Tall Storage Cabinet | 23. Glassware Washer | 35. Multi-media Projector (Ceiling Mount) |
| 12. Vented Flammable Storage Cabinet | 24. Glassware Dryer | 36. File Cabinet |

DEPARTMENT: GENOMICS
SPACE NAME: RESEARCH LABORATORY OPTION "B"
INDEX NO.: 2.01A
AREA: 315 ASF/MODULE



This diagram is conceptual and is provided only to indicate required furnishings, equipment, and general room proportions. The actual room design may change.

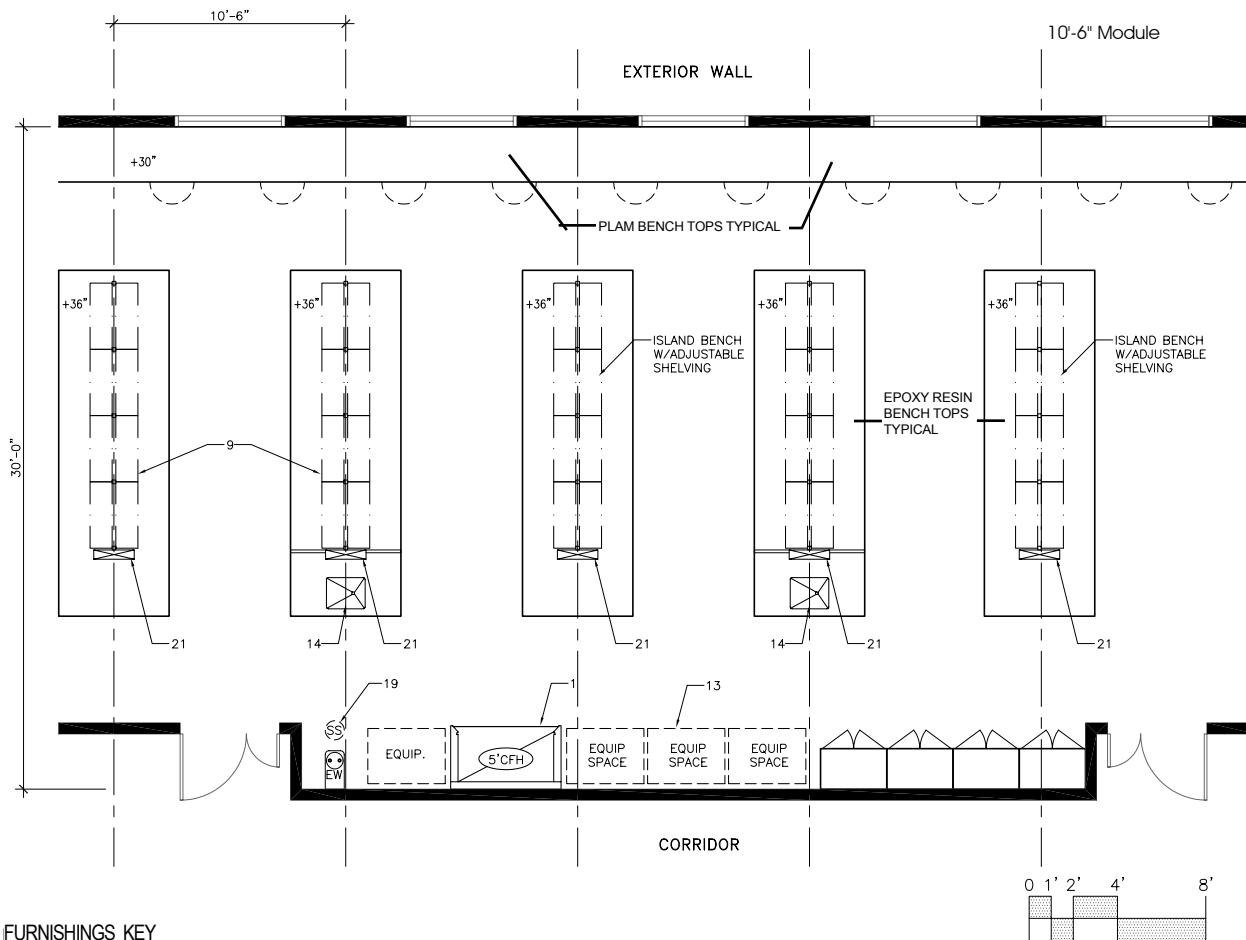

FURNISHINGS KEY

- | | | |
|--------------------------------------|----------------------------------|---|
| 1. Chemical Fume Hood | 13. Equipment Space | 25. Autoclave |
| 2. Biological Safety Cabinet | 14. Laboratory Sink | 26. Moveable Laboratory Table |
| 3. Radioisotope Hood | 15. Cupsink | 27. Wire Shelving |
| 4. Laminar Flow Hood | 16. Processing Sink | 28. Heavy Duty Shelving Unit |
| 5. Snorkel Exhaust | 17. Cylinder Rack | 29. White Markerboard |
| 6. Laboratory Bench, Standing Height | 18. Gas Cabinet | 30. Tackboard |
| 7. Laboratory Bench, Sifting Height | 19. Safety Shower/Eyewash | 31. Tech Desk |
| 8. Wall Cabinet | 20. Overhead Service Carrier | 32. Balance Table |
| 9. Adjustable Shelves | 21. Pipe Drop Enclosure | 33. Writing Table |
| 10. Reagent Shelves | 22. Moveable Demonstration Bench | 34. A/V Screen |
| 11. Tall Storage Cabinet | 23. Glassware Washer | 35. Multi-media Projector (Ceiling Mount) |
| 12. Vented Flammable Storage Cabinet | 24. Glassware Dryer | 36. File Cabinet |

DEPARTMENT: GENOMICS
SPACE NAME: RESEARCH LABORATORY OPTION "C"
INDEX NO.: 2.01
AREA: 315 NSF/MODULE



This diagram is conceptual and is provided only to indicate required furnishings, equipment, and general room proportions. The actual room design may change.

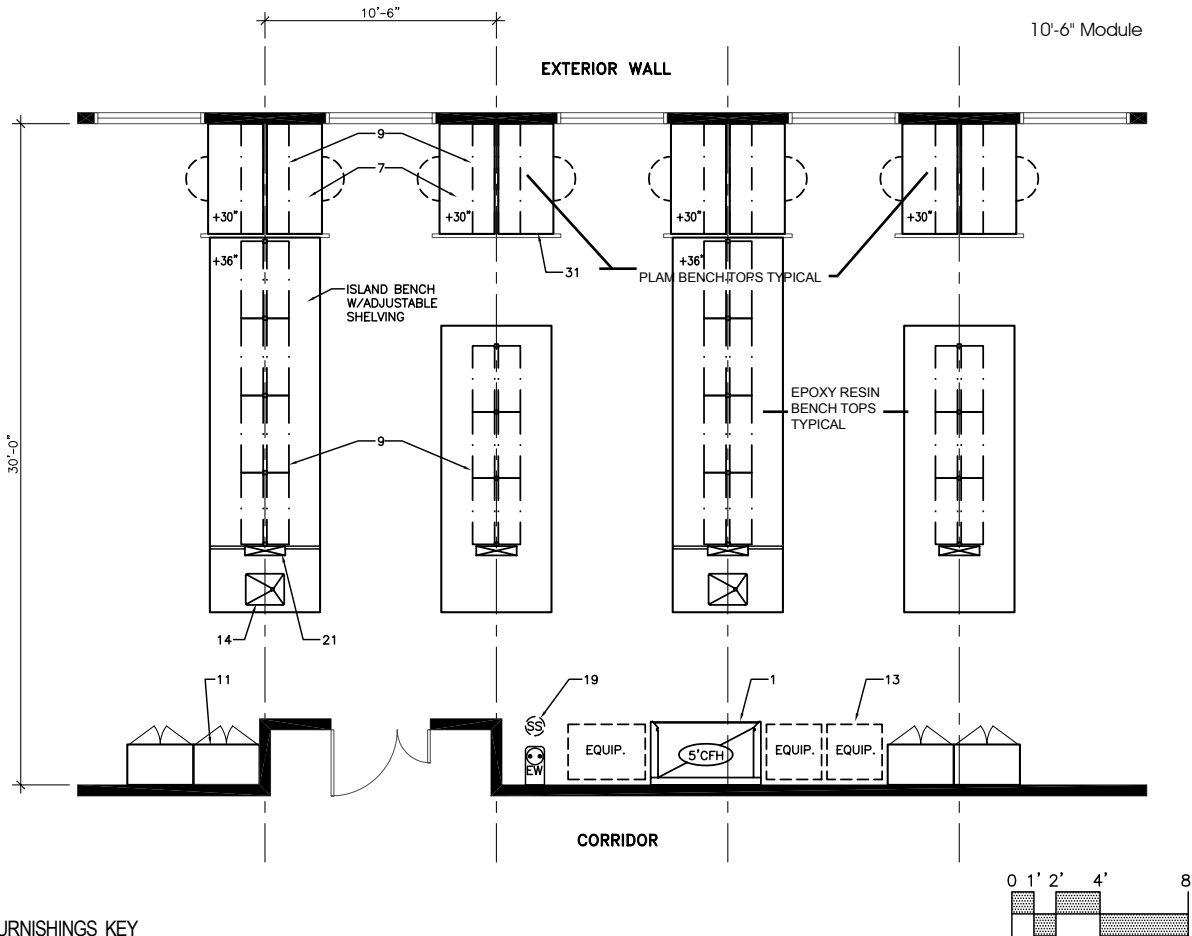

FURNISHINGS KEY

- | | | |
|--------------------------------------|----------------------------------|---|
| 1. Chemical Fume Hood | 13. Equipment Space | 25. Autoclave |
| 2. Biological Safety Cabinet | 14. Laboratory Sink | 26. Moveable Laboratory Table |
| 3. Radioisotope Hood | 15. Cupsink | 27. Wire Shelving |
| 4. Vented Workstation | 16. Processing Sink | 28. White Markerboard |
| 5. Snorkel Exhaust | 17. Cylinder Rack | 29. Black Chalkboard |
| 6. Laboratory Bench, Standing Height | 18. Gas Cabinet | 30. Tackboard |
| 7. Laboratory Bench, Sitting Height | 19. Safety Shower/Eyewash | 31. Tech Desk |
| 8. Wall Cabinet | 20. Overhead Service Carrier | 32. Balance Table |
| 9. Adjustable Shelves | 21. Pipe Drop Enclosure | 33. Writing Table |
| 10. Reagent Shelves | 22. Moveable Demonstration Bench | 34. A/V Screen |
| 11. Tall Storage Cabinet | 23. Glassware Washer | 35. Multi-media Projector (Ceiling Mount) |
| 12. Vented Flammable Storage Cabinet | 24. Glassware Dryer | 36. File Cabinet |

DEPARTMENT: GENOMICS
SPACE NAME: RESEARCH LABORATORY - CELLULAR
INDEX NO.: 2.02
OCCUPANCY:



UTILIZATION

Hours of Use
 8 hours/day _____
 14 hours/day _____
 24 hours/day _____
 Hours of Operation
 8 hours/day _____
 14 hours/day _____
 24 hours/day _____

SECURITY

No Lock _____
 Keyed Lock _____
 Cardkey _____

MECHANICAL

Temperature
 72°F ± 2°F _____
 68°-75° ± 2°F _____
 Other _____
 Humidity
 50% ± 20% _____
 Ambient _____
 15 Air Changes/Hour _____
 8 to 10 Air Changes/Hour _____
 6 Air Changes/Hour _____
 100% Make-up Air _____
 Recirculated Air _____
 Air Pressure Positive _____
 Air Pressure Negative _____
 Air Filtration/Supply _____

HOODS

Chemical Fume Hood Note 1. _____
 Radioisotope Hood _____
 Laminar Flow Hood _____
 Biological Safety Cabinet (OFOI) _____
 Snorkel _____
 Canopy Hood _____
 Other _____

LABORATORY EQUIPMENT

Vibration Sensitive _____
 Light Sensitive _____
 Vibration Producing _____
 Heat Producing _____
 Noise Producing _____

PLUMBING

Laboratory Gas (LG) _____
 Laboratory Vacuum (LV) _____
 Laboratory Air (LA) _____
 Compressed Air, 100 psi (A) _____
 Industrial Hot Water (IHW) _____
 Industrial Cold Water (ICW) _____
 Potable Cold Water _____
 Potable Hot Water _____
 High Purity Water (DI) _____
 Chilled Water (CHW S/R) _____
 Carbon Dioxide (CO₂) _____
 Nitrogen Gas (N₂) _____
 Cylinder Gases
 Inert _____
 Flammable _____
 Toxic _____
 Floor Drain (FD) _____
 Floor Sink (FS) _____
 Sediment Trap _____
 Safety Shower/Eyewash (SS) _____
 Drench Hose (DH) _____

ELECTRICAL

110V, 20A, 1 Phase _____
 208V, 30A, 1 Phase _____
 208V, 30A, 3 Phase _____
 480V, 100A, 3 Phase _____
 Isolated Ground Outlet _____
 Emergency Power _____
 UPS (OFOI) _____
 Voice / Data _____
 In Use Light _____
 Task Lighting _____
 Lighting Level
 50-60 fc direct/indirect _____
 75 fc at bench/desk _____
 Safe light _____
 Special Lighting _____
 Darkenable _____
 Zoned Lighting _____

CHEMICALS

Bases _____
 Acids _____
 Solvents _____
 Radioisotopes _____
 Carcinogens/Regulated _____
 Chemical Waste Storage _____
 Biological Storage _____
 Radioisotope Storage _____
 Chemical Storage _____

ARCHITECTURAL

Floor
 VCT (Chemical Resistant) _____
 VCT _____
 Welded Seam Sheet Vinyl _____
 Epoxy _____
 Carpet _____
 Low Static Carpet _____
 Sealed Concrete _____
 Partitions
 Gyp Board, Epoxy Paint _____
 Gyp Board, Paint _____
 Other _____
 Base
 4" Rubber _____
 Integral w/floor _____
 Ceiling
 Open _____
 Acoustic Tile _____
 Gyp Board, Epoxy Paint _____
 Height 9' min. _____
 Doors
 3'-6" x 7' _____
 3' x 7' _____
 1'-6" x 7' _____
 Light Tight Rotating Door _____
 Vision Panel _____
 Natural Daylight _____
ACOUSTICS
 Normal _____
 Privacy _____

REMARKS:

- In adjacent alcove - Allow (1) 6' CFH per two modules
- Epoxy resin tops at research benching
- Plam on tops at write-up
- Maple casework with clear finish
- Epoxy resin drop-in sinks
- Plan on writing arm surfaces

OWNER FURNISHED EQUIPMENT:

- Refrigerator
- PC's
-
-
-
-

DEPARTMENT: GENOMICS
SPACE NAME: RESEARCH LABORATORY OPTION "A"
INDEX NO.: 2.02
AREA: 945 ASF + 630 ASF



This diagram is conceptual and is provided only to indicate required furnishings, equipment, and general room proportions. The actual room design may change.

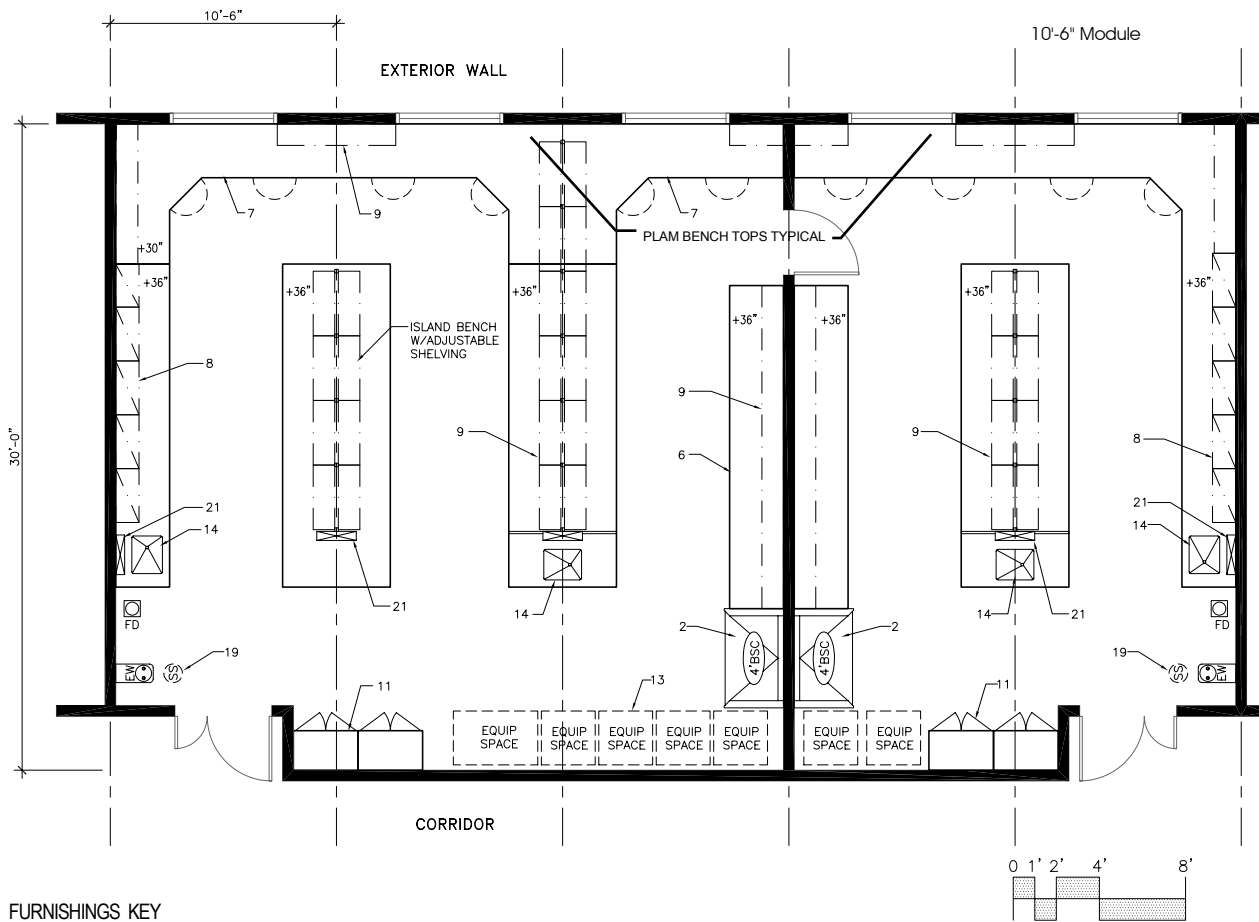

FURNISHINGS KEY

- | | | |
|--------------------------------------|----------------------------------|---|
| 1. Chemical Fume Hood | 13. Equipment Space | 25. Autoclave |
| 2. Biological Safety Cabinet | 14. Laboratory Sink | 26. Moveable Laboratory Table |
| 3. Radioisotope Hood | 15. Cupsink | 27. Wire Shelving |
| 4. Laminar Flow Hood | 16. Processing Sink | 28. Heavy Duty Shelving Unit |
| 5. Snorkel Exhaust | 17. Cylinder Rack | 29. White Markerboard |
| 6. Laboratory Bench, Standing Height | 18. Gas Cabinet | 30. Tackboard |
| 7. Laboratory Bench, Sitting Height | 19. Safety Shower/Eyewash | 31. Tech Desk |
| 8. Wall Cabinet | 20. Overhead Service Carrier | 32. Balance Table |
| 9. Adjustable Shelves | 21. Pipe Drop Enclosure | 33. Writing Table |
| 10. Reagent Shelves | 22. Moveable Demonstration Bench | 34. AV Screen |
| 11. Tall Storage Cabinet | 23. Glassware Washer | 35. Multi-media Projector (Ceiling Mount) |
| 12. Vented Flammable Storage Cabinet | 24. Glassware Dryer | 36. File Cabinet |

DEPARTMENT:
SPACE NAME:
INDEX NO.:
OCCUPANCY:

GENOMICS
BIONINFORMATICS RESEARCH LABORATORY
2.03



UTILIZATION

Hours of Use
 8 hours/day _____
 14 hours/day _____
 24 hours/day _____
 Hours of Operation
 8 hours/day _____
 14 hours/day _____
 24 hours/day _____

SECURITY

No Lock _____
 Keyed Lock _____
 Cardkey _____

MECHANICAL

Temperature
 72°F ± 2°F _____
 68°-75° ± 2°F _____
 Other _____
 Humidity
 50% ± 20% _____
 Ambient _____

15 Air Changes/Hour _____
 8 to10 Air Changes/Hour _____
 6 Air Changes/Hour _____
 100% Make-up Air _____
 Recirculated Air _____
 Air Pressure Positive _____
 Air Pressure Negative _____
 Air Filtration/Supply _____

HOODS

Chemical Fume Hood _____
 Radioisotope Hood _____
 Laminar Flow Hood _____
 Biological Safety Cabinet (OFOI) _____
 Snorkel _____
 Canopy Hood _____
 Other _____

LABORATORY EQUIPMENT

Vibration Sensitive _____
 Light Sensitive _____
 Vibration Producing _____
 Heat Producing _____
 Noise Producing _____

PLUMBING

Laboratory Gas (LG) _____
 Laboratory Vacuum (LV) _____
 Laboratory Air (LA) _____
 Compressed Air, 100 psi (A) _____
 Industrial Hot Water (IHW) _____
 Industrial Cold Water (ICW) _____
 Potable Cold Water _____
 Potable Hot Water _____
 High Purity Water (DI) _____
 Chilled Water (CHW S/R) _____
 Carbon Dioxide (CO₂) _____
 Nitrogen Gas (N₂) _____
 Cylinder Gases _____

Inert _____
 Flammable _____
 Toxic _____
 Floor Drain (FD) _____
 Floor Sink (FS) _____
 Sediment Trap _____
 Safety Shower/Eyewash (SS) _____
 Drench Hose (DH) _____

ELECTRICAL

110V, 20A, 1 Phase _____
 208V, 30A, 1 Phase _____
 208V, 30A, 3 Phase _____
 480V, 100A, 3 Phase _____
 Isolated Ground Outlet _____
 Emergency Power _____
 UPS (OFOI) _____
 Voice / Data _____
 In Use Light _____
 Task Lighting _____
 Lighting Level _____
 50-60 fc direct/indirect _____
 75 fc at bench/desk _____
 Safe light _____
 Special Lighting _____
 Darkenable _____
 Zoned Lighting _____

CHEMICALS

Bases _____
 Acids _____
 Solvents _____
 Radioisotopes _____
 Carcinogens/Regulated _____
 Chemical Waste Storage _____
 Biological Storage _____
 Radioisotope Storage _____
 Chemical Storage _____

ARCHITECTURAL

Floor
 VCT (Chemical Resistant) _____
 VCT _____
 Welded Seam Sheet Vinyl _____
 Epoxy _____
 Carpet _____
 Low Static Carpet _____
 Sealed Concrete _____
 Partitions
 Gyp Board, Epoxy Paint _____
 Gyp Board, Paint _____
 Other _____
 Base
 4" Rubber _____
 Integral w/floor _____
 Ceiling
 Open _____
 Acoustic Tile _____
 Gyp Board, Epoxy Paint _____
 Height 9' min.

Doors
 3'-6" x 7' _____
 3' x 7' _____
 1'-6" x 7' _____
 Light Tight Rotating Door _____
 Vision Panel _____
 Natural Daylight _____
ACOUSTICS
 Normal _____
 Privacy _____
AV EQUIPMENT
 Projection Screen _____
 Data _____
 etc. _____

REMARKS:

1. Plastic laminate tops
2. Maple casework with clear finish
- 3.

OWNER FURNISHED EQUIPMENT:

- a. PC's
- b. Printer
- c. Multi-media projector

DEPARTMENT: GENOMICS
SPACE NAME: BIOINFORMATICS RESEARCH LABORATORY
INDEX NO.: 2.03
AREA: 400 ASF



This diagram is conceptual and is provided only to indicate required furnishings, equipment, and general room proportions. The actual room design may change.

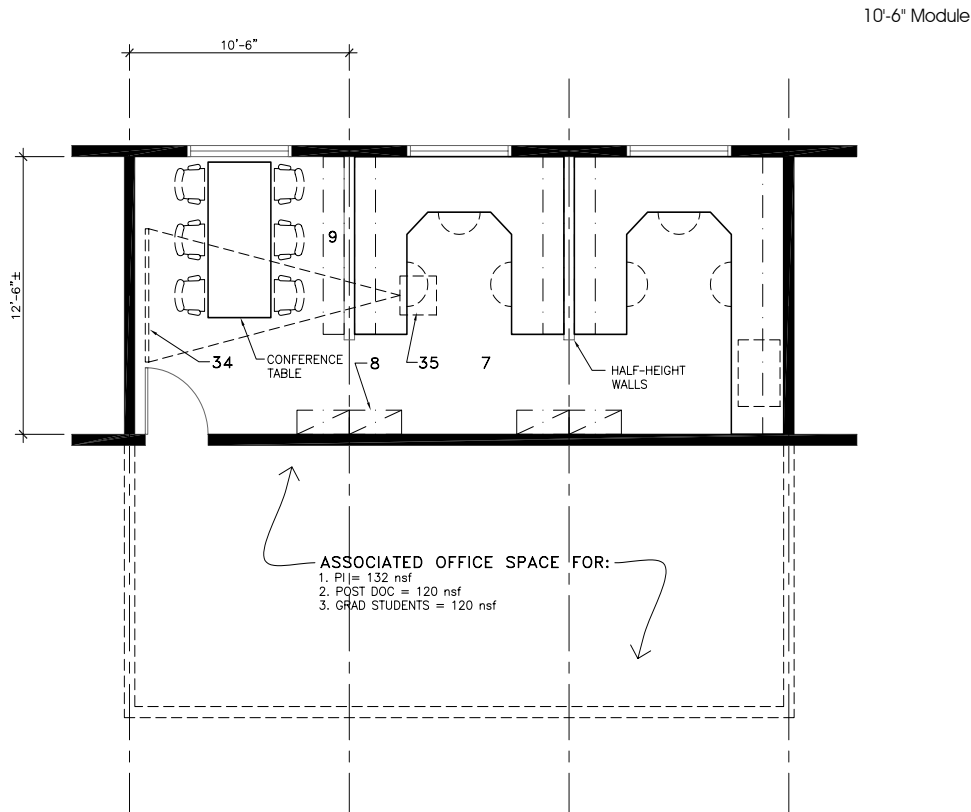

FURNISHINGS KEY

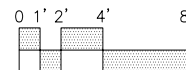

- | | | |
|--------------------------------------|----------------------------------|---|
| 1. Chemical Fume Hood | 13. Equipment Space | 25. Autoclave |
| 2. Biological Safety Cabinet | 14. Laboratory Sink | 26. Moveable Laboratory Table |
| 3. Radioisotope Hood | 15. Cupsink | 27. Wire Shelving |
| 4. Laminar Flow Hood | 16. Processing Sink | 28. Heavy Duty Shelving Unit |
| 5. Snorkel Exhaust | 17. Cylinder Rack | 29. White Markerboard |
| 6. Laboratory Bench, Standing Height | 18. Gas Cabinet | 30. Tackboard |
| 7. Laboratory Bench, Sitting Height | 19. Safety Shower/Eyewash | 31. Tech Desk |
| 8. Wall Cabinet | 20. Overhead Service Carrier | 32. Balance Table |
| 9. Adjustable Shelves | 21. Pipe Drop Enclosure | 33. Writing Table |
| 10. Reagent Shelves | 22. Moveable Demonstration Bench | 34. A/V Screen |
| 11. Tall Storage Cabinet | 23. Glassware Washer | 35. Multi-media Projector (Ceiling Mount) |
| 12. Vented Flammable Storage Cabinet | 24. Glassware Dryer | 36. File Cabinet |

DEPARTMENT: GENOMICS
SPACE NAME: EQUIPMENT ROOM
INDEX NO.: 3.01
OCCUPANCY:



UTILIZATION

Hours of Use
 8 hours/day _____
 14 hours/day _____
 24 hours/day _____
 Hours of Operation
 8 hours/day _____
 14 hours/day _____
 24 hours/day _____

SECURITY

No Lock _____
 Keyed Lock _____
 Cardkey _____

MECHANICAL

Temperature
 72°F ± 2°F _____
 68°-75° ± 2°F _____
 Other _____
 Humidity
 50% ± 20% _____
 Ambient _____
 15 Air Changes/Hour _____
 8 to 10 Air Changes/Hour Note 1.
 6 Air Changes/Hour _____
 100% Make-up Air Note 2.
 Recirculated Air _____
 Air Pressure Positive _____
 Air Pressure Negative _____
 Air Filtration/Supply _____

HOODS

Chemical Fume Hood _____
 Radioisotope Hood _____
 Laminar Flow Hood _____
 Biological Safety Cabinet (OFOI) _____
 Snorkel _____
 Canopy Hood _____
 Other _____

LABORATORY EQUIPMENT

Vibration Sensitive _____
 Light Sensitive _____
 Vibration Producing _____
 Heat Producing _____
 Noise Producing _____

PLUMBING

Laboratory Gas (LG) _____
 Laboratory Vacuum (LV) _____
 Laboratory Air (LA) _____
 Compressed Air, 100 psi (A) _____
 Industrial Hot Water (IHW) _____
 Industrial Cold Water (ICW) _____
 Potable Cold Water _____
 Potable Hot Water _____
 High Purity Water (DI) _____
 Chilled Water (CHW S/R) _____
 Carbon Dioxide (CO₂) _____
 Nitrogen Gas (N₂) _____
 Cylinder Gases _____
 Inert _____
 Flammable _____
 Toxic _____
 Floor Drain (FD) _____
 Floor Sink (FS) _____
 Sediment Trap _____
 Safety Shower/Eyewash (SS) _____
 Drench Hose (DH) _____
ELECTRICAL
 110V, 20A, 1 Phase _____
 208V, 30A, 1 Phase _____
 208V, 30A, 3 Phase _____
 480V, 100A, 3 Phase _____
 Isolated Ground Outlet _____

UPS (OFOI) _____
 Voice / Data _____
 In Use Light _____
 Task Lighting _____
 Lighting Level
 50-60 fc direct/indirect _____
 75 fc at bench/desk _____
 Safe light _____
 Special Lighting _____
 Darkenable _____
 Zoned Lighting _____

CHEMICALS

Bases _____
 Acids _____
 Solvents _____
 Radioisotopes _____
 Carcinogens/Regulated _____
 Chemical Waste Storage _____
 Biological Storage _____
 Radioisotope Storage _____
 Chemical Storage _____

ARCHITECTURAL

Floor
 VCT (Chemical Resistant) _____
 VCT _____
 Welded Seam Sheet Vinyl _____
 Epoxy _____
 Carpet _____
 Low Static Carpet _____
 Sealed Concrete _____
 Partitions
 Gyp Board, Epoxy Paint _____
 Gyp Board, Paint _____
 Other _____
 Base
 4" Rubber _____
 Integral w/floor _____
 Ceiling
 Open _____
 Acoustic Tile _____
 Gyp Board, Epoxy Paint _____
 Height _____
 Doors
 3'-6" x 7' _____
 3' x 7' _____
 1'-6" x 7' _____
 Light Tight Rotating Door _____
 Vision Panel _____
 Natural Daylight _____
ACOUSTICS
 Normal _____
 Privacy _____

REMARKS:

- Heat loads from equipment will drive the air quantity in this room
- Air could be recirculated within this room
-
-

OWNER FURNISHED EQUIPMENT:

- 80°C Freezers
- 20°C Freezers
- Centrifuges
- Growth chambers

DEPARTMENT: GENOMICS
SPACE NAME: EQUIPMENT ROOM
INDEX NO.: 3.01
AREA: 315 ASF



This diagram is conceptual and is provided only to indicate required furnishings, equipment, and general room proportions. The actual room design may change.

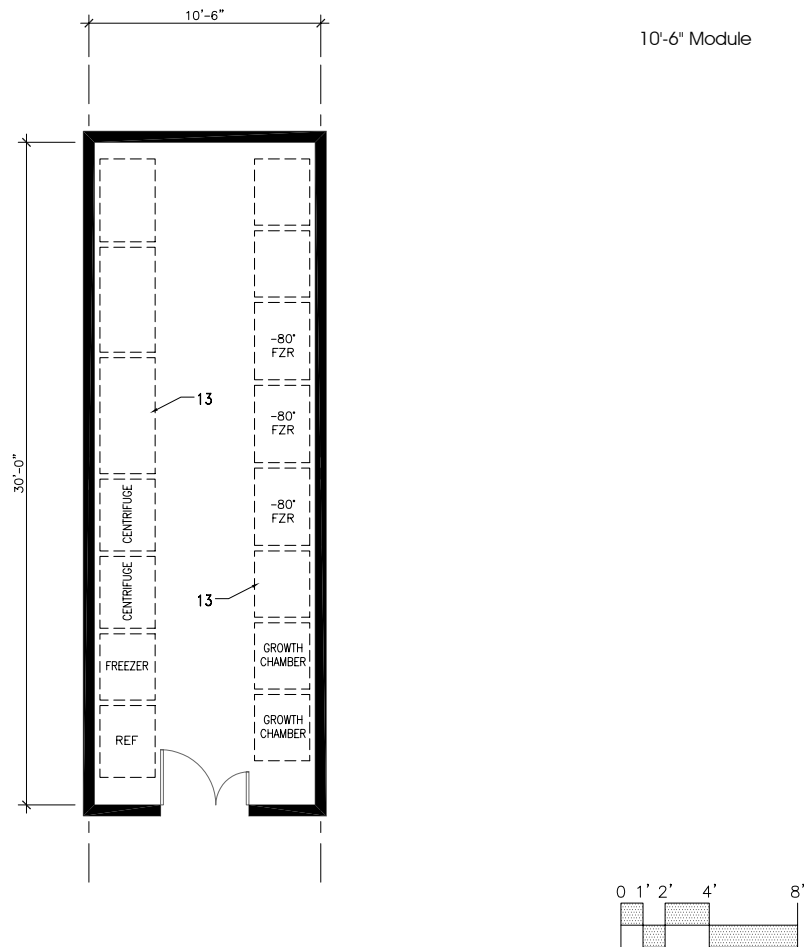

FURNISHINGS KEY

- | | | |
|--------------------------------------|----------------------------------|---|
| 1. Chemical Fume Hood | 13. Equipment Space | 25. Autoclave |
| 2. Biological Safety Cabinet | 14. Laboratory Sink | 26. Moveable Laboratory Table |
| 3. Radioisotope Hood | 15. Cupsink | 27. Wire Shelving |
| 4. Laminar Flow Hood | 16. Processing Sink | 28. Heavy Duty Shelving Unit |
| 5. Snorkel Exhaust | 17. Cylinder Rack | 29. White Markerboard |
| 6. Laboratory Bench, Standing Height | 18. Gas Cabinet | 30. Tackboard |
| 7. Laboratory Bench, Sitting Height | 19. Safety Shower/Eyewash | 31. Tech Desk |
| 8. Wall Cabinet | 20. Overhead Service Carrier | 32. Balance Table |
| 9. Adjustable Shelves | 21. Pipe Drop Enclosure | 33. Writing Table |
| 10. Reagent Shelves | 22. Moveable Demonstration Bench | 34. A/V Screen |
| 11. Tall Storage Cabinet | 23. Glassware Washer | 35. Multi-media Projector (Ceiling Mount) |
| 12. Vented Flammable Storage Cabinet | 24. Glassware Dryer | 36. File Cabinet |

DEPARTMENT:
SPACE NAME:
INDEX NO.:
OCCUPANCY:

GENOMICS
DARK ROOM
3.02



UTILIZATION

Hours of Use
 8 hours/day _____
 14 hours/day _____
 24 hours/day _____
 Hours of Operation
 8 hours/day _____
 14 hours/day _____
 24 hours/day _____

SECURITY

No Lock _____
 Keyed Lock _____
 Cardkey _____

MECHANICAL

Temperature
 72°F ± 2°F _____
 68°-75° ± 2°F _____
 Other _____
 Humidity
 50% ± 20% _____
 Ambient _____
 15 Air Changes/Hour _____
 8 to10 Air Changes/Hour _____
 6 Air Changes/Hour _____
 100% Make-up Air _____
 Recirculated Air _____
 Air Pressure Positive _____
 Air Pressure Negative _____
 Air Filtration/Supply _____

HOODS

Chemical Fume Hood _____
 Radioisotope Hood _____
 Laminar Flow Hood _____
 Biological Safety Cabinet (OFOI) _____
 Snorkel _____
 Canopy Hood _____
 Other _____

LABORATORY EQUIPMENT

Vibration Sensitive _____
 Light Sensitive _____
 Vibration Producing _____
 Heat Producing _____
 Noise Producing _____

PLUMBING

Laboratory Gas (LG) _____
 Laboratory Vacuum (LV) _____
 Laboratory Air (LA) _____
 Compressed Air, 100 psi (A) _____
 Industrial Hot Water (IHW) _____
 Industrial Cold Water (ICW) _____
 Potable Cold Water _____
 Potable Hot Water _____
 High Purity Water (DI) _____
 Chilled Water (CHW S/R) _____
 Carbon Dioxide (CO₂) _____
 Nitrogen Gas (N₂) _____
 Cylinder Gases _____
 Inert _____
 Flammable _____
 Toxic _____
 Floor Drain (FD) _____
 Floor Sink (FS) _____
 Sediment Trap _____
 Safety Shower/Eyewash (SS) _____
 Drench Hose (DH) _____

ELECTRICAL

110V, 20A, 1 Phase _____
 208V, 30A, 1 Phase _____
 208V, 30A, 3 Phase _____
 480V, 100A, 3 Phase _____
 Isolated Ground Outlet _____
 Emergency Power _____
 UPS (OFOI) _____
 Voice / Data _____
 In Use Light _____
 Task Lighting _____
 Lighting Level _____
 100 fc at bench/desk _____
 75 fc at bench/desk _____
 Safe light _____
 Special Lighting _____
 Darkenable _____
 Zoned Lighting _____

CHEMICALS

Bases _____
 Acids _____
 Solvents _____
 Radioisotopes _____
 Carcinogens/Regulated _____
 Chemical Waste Storage _____
 Biological Storage _____
 Radioisotope Storage _____
 Chemical Storage _____

ARCHITECTURAL

Floor
 VCT (Chemical Resistant) _____
 VCT _____
 Welded Seam Sheet Vinyl _____
 Epoxy _____
 Carpet _____
 Low Static Carpet _____
 Sealed Concrete _____
 Partitions
 Gyp Board, Epoxy Paint _____
 Gyp Board, Paint _____
 Other _____
 Base
 4" Rubber _____
 Integral w/floor _____
 Ceiling
 Open _____
 Acoustic Tile _____
 Gyp Board, Epoxy Paint _____
 Height _____
 Doors
 3'-6" x 7' _____
 3' x 7' _____
 1'-6" x 7' _____
 Light Tight Door _____
 Vision Panel _____
 Natural Daylight _____
ACOUSTICS
 Normal _____
 Privacy _____

REMARKS:

1. Plastic laminate tops
2. Plastic laminate casework (light tight)
3. Polypropylene process sink.

OWNER FURNISHED EQUIPMENT:

- a. Film processor
- b.
- c.

DEPARTMENT: GENOMICS
SPACE NAME: DARK ROOM
INDEX NO.: 3.02
AREA: 105 ASF



This diagram is conceptual and is provided only to indicate required furnishings, equipment, and general room proportions. The actual room design may change.

10'-6" Module

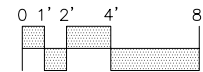
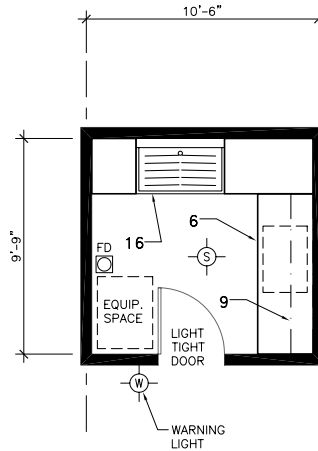

FURNISHINGS KEY

- | | | |
|--------------------------------------|----------------------------------|---|
| 1. Chemical Fume Hood | 13. Equipment Space | 25. Autoclave |
| 2. Biological Safety Cabinet | 14. Laboratory Sink | 26. Moveable Laboratory Table |
| 3. Radioisotope Hood | 15. Cupsink | 27. Wire Shelving |
| 4. Laminar Flow Hood | 16. Processing Sink | 28. Heavy Duty Shelving Unit |
| 5. Snorkel Exhaust | 17. Cylinder Rack | 29. White Markerboard |
| 6. Laboratory Bench, Standing Height | 18. Gas Cabinet | 30. Tackboard |
| 7. Laboratory Bench, Sitting Height | 19. Safety Shower/Eyewash | 31. Tech Desk |
| 8. Wall Cabinet | 20. Overhead Service Carrier | 32. Balance Table |
| 9. Adjustable Shelves | 21. Pipe Drop Enclosure | 33. Writing Table |
| 10. Reagent Shelves | 22. Moveable Demonstration Bench | 34. A/V Screen |
| 11. Tall Storage Cabinet | 23. Glassware Washer | 35. Multi-media Projector (Ceiling Mount) |
| 12. Vented Flammable Storage Cabinet | 24. Glassware Dryer | 36. File Cabinet |

DEPARTMENT:
SPACE NAME:
INDEX NO.:
OCCUPANCY:

GENOMICS
AUTOCLAVE/GLASSWASH
3.03



UTILIZATION

Hours of Use
 8 hours/day _____
 14 hours/day _____
 24 hours/day _____
 Hours of Operation
 8 hours/day _____
 14 hours/day _____
 24 hours/day _____

SECURITY

No Lock _____
 Keyed Lock _____
 Cardkey _____

MECHANICAL

Temperature
 72°F ± 2°F _____
 68°-75° ± 2°F _____
 Other _____
 Humidity
 50% ± 20% _____
 Ambient _____

15 Air Changes/Hour _____
 8 to 10 Air Changes/Hour _____
 6 Air Changes/Hour _____
 100% Make-up Air _____
 Recirculated Air _____
 Air Pressure Positive _____
 Air Pressure Negative _____
 Air Filtration/Supply _____

HOODS

Chemical Fume Hood _____
 Radioisotope Hood _____
 Laminar Flow Hood _____
 Biological Safety Cabinet (OFOI) _____
 Snorkel _____
 Canopy Hood Note 1.
 Other _____

LABORATORY EQUIPMENT

Vibration Sensitive _____
 Light Sensitive _____
 Vibration Producing _____
 Heat Producing _____
 Noise Producing _____

PLUMBING

Laboratory Gas (LG) _____
 Laboratory Vacuum (LV) _____
 Laboratory Air (LA) _____
 Compressed Air, 100 psi (A) _____
 Industrial Hot Water (IHW) _____
 Industrial Cold Water (ICW) _____
 Potable Cold Water _____
 Potable Hot Water _____
 High Purity Water (DI) _____
 Chilled Water (CHW S/R) _____
 Carbon Dioxide (CO₂) _____
 Nitrogen Gas (N₂) _____
 Cylinder Gases
 Inert _____
 Flammable _____
 Toxic _____
 Floor Drain (FD) _____
 Floor Sink (FS) _____
 Sediment Trap _____
 Safety Shower/Eyewash (SS) _____
 Drench Hose (DH) _____

ELECTRICAL

110V, 20A, 1 Phase _____
 208V, 30A, 1 Phase _____
 208V, 30A, 3 Phase _____
 480V, 100A, 3 Phase _____
 Isolated Ground Outlet _____
 Emergency Power _____
 UPS (OFOI) _____
 Voice / Data _____
 In Use Light _____
 Task Lighting _____
 Lighting Level
 100 fc at bench/desk _____
 75 fc at bench/desk _____
 Safe light _____
 Special Lighting _____
 Darkenable _____
 Zoned Lighting _____

CHEMICALS

Bases _____
 Acids _____
 Solvents _____
 Radioisotopes _____
 Carcinogens/Regulated _____
 Chemical Waste Storage _____
 Biological Storage _____
 Radioisotope Storage _____
 Chemical Storage _____

ARCHITECTURAL

Floor
 VCT (Chemical Resistant) _____
 VCT _____
 Welded Seam Sheet Vinyl _____
 Epoxy _____
 Carpet _____
 Low Static Carpet _____
 Sealed Concrete _____
 Partitions
 Gyp Board, Epoxy Paint _____
 Gyp Board, Paint _____
 Other _____
 Base
 4" Rubber _____
 Integral w/floor _____
 Ceiling
 Open _____
 Acoustic Tile _____
 Gyp Board, Epoxy Paint _____
 Height _____
 Doors
 3'-6" x 7' _____
 3' x 7' _____
 1'-6" x 7' _____
 Light Tight Door _____
 Vision Panel _____
 Natural Daylight _____
ACOUSTICS
 Normal _____
 Privacy _____

REMARKS:

1. 4' deep and width of equipment wall.
2. Energy and water conservation controls on all autoclaves
3. Stainless steel tops
4. Stainless steel sinks
5. Painted steel casework

OWNER FURNISHED EQUIPMENT:

- a. Autoclave
- b. Future Autoclave
- c. (2) Future undercounter glassware v
- d.
- e.

DEPARTMENT: GENOMICS
SPACE NAME: CENTRAL GLASSWASH/AUTOClave
INDEX NO.: 3.03
AREA: 473 ASF



This diagram is conceptual and is provided only to indicate required furnishings, equipment, and general room proportions. The actual room design may change.

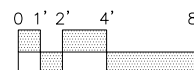
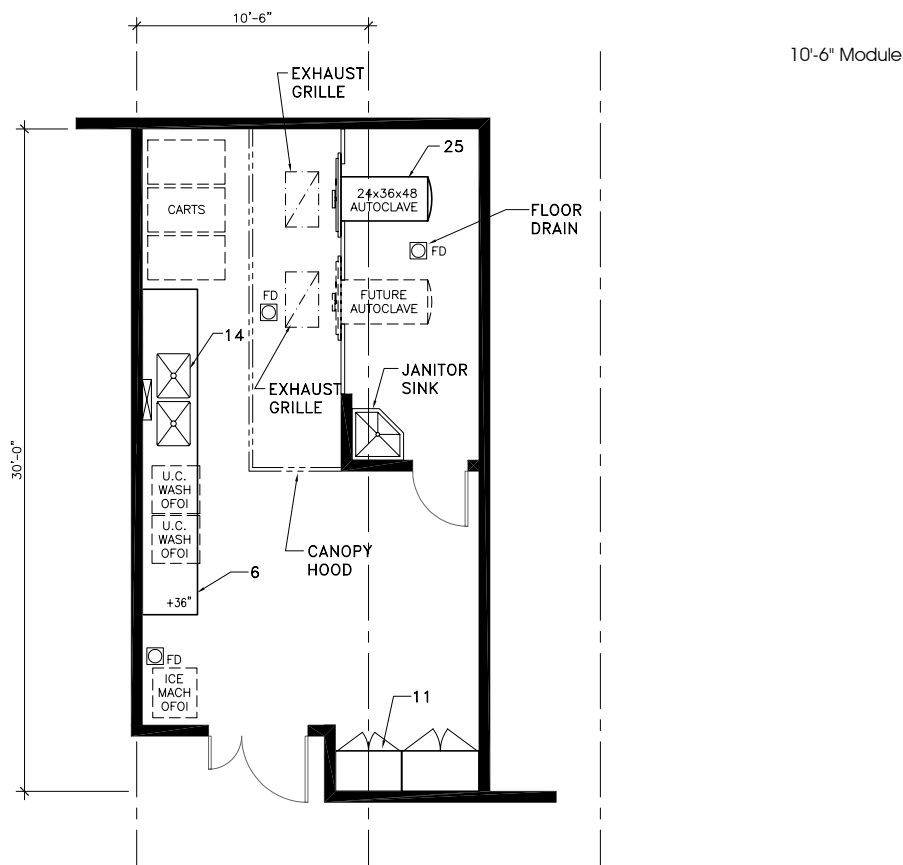

FURNISHINGS KEY

- | | | |
|--------------------------------------|----------------------------------|---|
| 1. Chemical Fume Hood | 13. Equipment Space | 25. Autoclave |
| 2. Biological Safety Cabinet | 14. Laboratory Sink | 26. Moveable Laboratory Table |
| 3. Radioisotope Hood | 15. Cupsink | 27. Wire Shelving |
| 4. Laminar Flow Hood | 16. Processing Sink | 28. Heavy Duty Shelving Unit |
| 5. Snorkel Exhaust | 17. Cylinder Rack | 29. White Markerboard |
| 6. Laboratory Bench, Standing Height | 18. Gas Cabinet | 30. Tackboard |
| 7. Laboratory Bench, Sitting Height | 19. Safety Shower/Eyewash | 31. Tech Desk |
| 8. Wall Cabinet | 20. Overhead Service Carrier | 32. Balance Table |
| 9. Adjustable Shelves | 21. Pipe Drop Enclosure | 33. Writing Table |
| 10. Reagent Shelves | 22. Moveable Demonstration Bench | 34. AV Screen |
| 11. Tall Storage Cabinet | 23. Glassware Washer | 35. Multi-media Projector (Ceiling Mount) |
| 12. Vented Flammable Storage Cabinet | 24. Glassware Dryer | 36. File Cabinet |

DEPARTMENT: GENOMICS
SPACE NAME: RADIOISOTOPE ROOM
INDEX NO.: 3.04
OCCUPANCY:



UTILIZATION

Hours of Use
 8 hours/day _____
 14 hours/day _____
 24 hours/day _____
 Hours of Operation
 8 hours/day _____
 14 hours/day _____
 24 hours/day _____

SECURITY

No Lock _____
 Keyed Lock _____
 Cardkey _____

MECHANICAL

Temperature
 72°F ± 2°F _____
 68°-75° ± 2°F _____
 Other _____
 Humidity
 50% ± 20% _____
 Ambient _____

15 Air Changes/Hour _____
 8 to 10 Air Changes/Hour _____
 6 Air Changes/Hour _____
 100% Make-up Air _____
 Recirculated Air _____
 Air Pressure Positive _____
 Air Pressure Negative _____
 Air Filtration/Supply _____

HOODS

Chemical Fume Hood _____
 Radioisotope Hood Note 1.
 Laminar Flow Hood _____
 Biological Safety Cabinet (OFOI) _____
 Snorkel _____
 Canopy Hood _____
 Other _____

LABORATORY EQUIPMENT

Vibration Sensitive _____
 Light Sensitive _____
 Vibration Producing _____
 Heat Producing _____
 Noise Producing _____

PLUMBING

Laboratory Gas (LG) _____
 Laboratory Vacuum (LV) _____
 Laboratory Air (LA) _____
 Compressed Air, 100 psi (A) _____
 Industrial Hot Water (IHW) _____
 Industrial Cold Water (ICW) _____
 Potable Cold Water _____
 Potable Hot Water _____
 High Purity Water (DI) _____
 Chilled Water (CHW S/R) _____
 Carbon Dioxide (CO₂) _____
 Nitrogen Gas (N₂) _____
 Cylinder Gases

Inert _____
 Flammable _____
 Toxic _____
 Floor Drain (FD) _____
 Floor Sink (FS) _____
 Sediment Trap _____
 Safety Shower/Eyewash (SS) _____
 Drench Hose (DH) _____

ELECTRICAL

110V, 20A, 1 Phase _____
 208V, 30A, 1 Phase _____
 208V, 30A, 3 Phase _____
 480V, 100A, 3 Phase _____
 Isolated Ground Outlet _____
 Emergency Power _____
 UPS (OFOI) _____
 Voice / Data _____
 In Use Light _____
 Task Lighting _____
 Lighting Level
 50-60 fc direct/indirect _____
 75 fc at bench/desk _____
 Safe light _____
 Special Lighting _____
 Darkenable _____
 Zoned Lighting _____

CHEMICALS

Bases _____
 Acids _____
 Solvents _____
 Radioisotopes _____
 Carcinogens/Regulated _____
 Chemical Waste Storage _____
 Biological Storage _____
 Radioisotope Storage _____
 Chemical Storage _____

ARCHITECTURAL

Floor
 VCT (Chemical Resistant) _____
 VCT _____
 Welded Seam Sheet Vinyl _____
 Epoxy _____
 Carpet _____
 Low Static Carpet _____
 Sealed Concrete _____
 Partitions
 Gyp Board, Epoxy Paint _____
 Gyp Board, Paint _____
 Other _____
 Base
 4" Rubber _____
 Integral w/floor _____
 Ceiling
 Open _____
 Acoustic Tile _____
 Gyp Board, Epoxy Paint _____
 Height _____
 Doors
 3'-6" x 7' _____
 3' x 7' _____
 1'-6" x 7' _____
 Light Tight Door _____
 Vision Panel _____
 Natural Daylight _____

ACOUSTICS

Normal _____
 Privacy _____

REMARKS:

1. (1) 6' RIH
2. Stainless steel tops
3. Stainless steel sink
4. Maple casework with clear finish

OWNER FURNISHED EQUIPMENT:

- a. Lead lined storage unit
- b.
- c.
- d.

DEPARTMENT: GENOMICS
SPACE NAME: RADIOISOTOPE ROOM
INDEX NO.: 3.04
AREA: 158 ASF



This diagram is conceptual and is provided only to indicate required furnishings, equipment, and general room proportions. The actual room design may change.

10'-6" Module

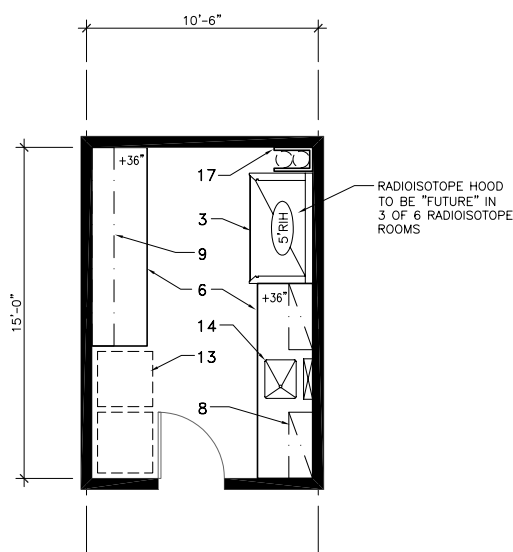

FURNISHINGS KEY

- | | | |
|--------------------------------------|----------------------------------|---|
| 1. Chemical Fume Hood | 13. Equipment Space | 25. Autoclave |
| 2. Biological Safety Cabinet | 14. Laboratory Sink | 26. Moveable Laboratory Table |
| 3. Radioisotope Hood | 15. Cupsink | 27. Wire Shelving |
| 4. Laminar Flow Hood | 16. Processing Sink | 28. Heavy Duty Shelving Unit |
| 5. Snorkel Exhaust | 17. Cylinder Rack | 29. White Markerboard |
| 6. Laboratory Bench, Standing Height | 18. Gas Cabinet | 30. Tackboard |
| 7. Laboratory Bench, Sitting Height | 19. Safety Shower/Eyewash | 31. Tech Desk |
| 8. Wall Cabinet | 20. Overhead Service Carrier | 32. Balance Table |
| 9. Adjustable Shelves | 21. Pipe Drop Enclosure | 33. Writing Table |
| 10. Reagent Shelves | 22. Moveable Demonstration Bench | 34. AV Screen |
| 11. Tall Storage Cabinet | 23. Glassware Washer | 35. Multi-media Projector (Ceiling Mount) |
| 12. Vented Flammable Storage Cabinet | 24. Glassware Dryer | 36. File Cabinet |

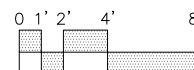

DEPARTMENT: GENOMICS
SPACE NAME: GROWTH CHAMBER/EQUIPMENT ROOM
INDEX NO.: 3.05
OCCUPANCY:



UTILIZATION

Hours of Use
 8 hours/day _____
 14 hours/day
 24 hours/day _____
 Hours of Operation
 8 hours/day _____
 14 hours/day _____
 24 hours/day

SECURITY

No Lock _____
 Keyed Lock
 Cardkey _____

MECHANICAL

Temperature
 72°F ± 2°F _____
 68°-75° ± 2°F
 Other _____
 Humidity
 50% ± 20% _____
 Ambient

15 Air Changes/Hour _____
 8 to 10 Air Changes/Hour
 6 Air Changes/Hour _____
 100% Make-up Air Note 1.
 Recirculated Air _____
 Air Pressure Positive _____
 Air Pressure Negative
 Air Filtration/Supply _____

HOODS

Chemical Fume Hood _____
 Radioisotope Hood _____
 Laminar Flow Hood _____
 Biological Safety Cabinet (OFOI) _____
 Snorkel _____
 Canopy Hood _____
 Other _____

LABORATORY EQUIPMENT

Vibration Sensitive _____
 Light Sensitive _____
 Vibration Producing
 Heat Producing
 Noise Producing

PLUMBING

Laboratory Gas (LG) _____
 Laboratory Vacuum (LV) _____
 Laboratory Air (LA) _____
 Compressed Air, 100 psi (A)
 Industrial Hot Water (IHW) _____
 Industrial Cold Water (ICW) _____
 Potable Cold Water _____
 Potable Hot Water _____
 High Purity Water (DI) _____
 Chilled Water (CHW S/R)
 Carbon Dioxide (CO₂) _____
 Nitrogen Gas (N₂) _____
 Cylinder Gases
 Inert _____
 Flammable _____
 Toxic _____
 Floor Drain (FD)
 Floor Sink (FS) _____
 Sediment Trap _____
 Safety Shower/Eyewash (SS) _____
 Drench Hose (DH) _____

ELECTRICAL

110V, 20A, 1 Phase
 208V, 30A, 1 Phase
 208V, 30A, 3 Phase
 480V, 100A, 3 Phase _____
 Isolated Ground Outlet
 Emergency Power
 UPS (OFOI) _____
 Voice / Data
 In Use Light _____
 Task Lighting _____
 Lighting Level
 50-60 fc direct/indirect
 75 fc at bench/desk _____
 Safe light _____
 Special Lighting _____
 Darkenable _____
 Zoned Lighting _____

CHEMICALS

Bases _____
 Acids _____
 Solvents _____
 Radioisotopes _____
 Carcinogens/Regulated _____
 Chemical Waste Storage _____
 Biological Storage
 Radioisotope Storage _____
 Chemical Storage _____

ARCHITECTURAL

Floor
 VCT (Chemical Resistant) _____
 VCT
 Welded Seam Sheet Vinyl _____
 Epoxy _____
 Carpet _____
 Low Static Carpet _____
 Sealed Concrete _____
 Partitions
 Gyp Board, Epoxy Paint _____
 Gyp Board, Paint
 Other _____
 Base
 4" Rubber
 Integral w/floor _____
 Ceiling
 Open
 Acoustic Tile _____
 Gyp Board, Epoxy Paint _____
 Height _____
 Doors
 3'-6" x 7' _____
 3' x 7'
 1'-6" x 7'
 Light Tight Rotating Door _____
 Vision Panel
 Natural Daylight _____
ACOUSTICS
 Normal
 Privacy _____

REMARKS:

1. Air could be recirculated within this room
2. Proximity to sterilizer
3. Epoxy resin tops
4. Epoxy resin drop-in sink
5. Maple casework with clear finish

OWNER FURNISHED EQUIPMENT:

- a. (6 to 8) Growth Chambers
- b. -80°C Freezers
- c.
- d.
- e.

DEPARTMENT: GENOMICS
SPACE NAME: GROWTH CHAMBERS
INDEX NO.: 3.05
AREA: 315 ASF



This diagram is conceptual and is provided only to indicate required furnishings, equipment, and general room proportions. The actual room design may change.

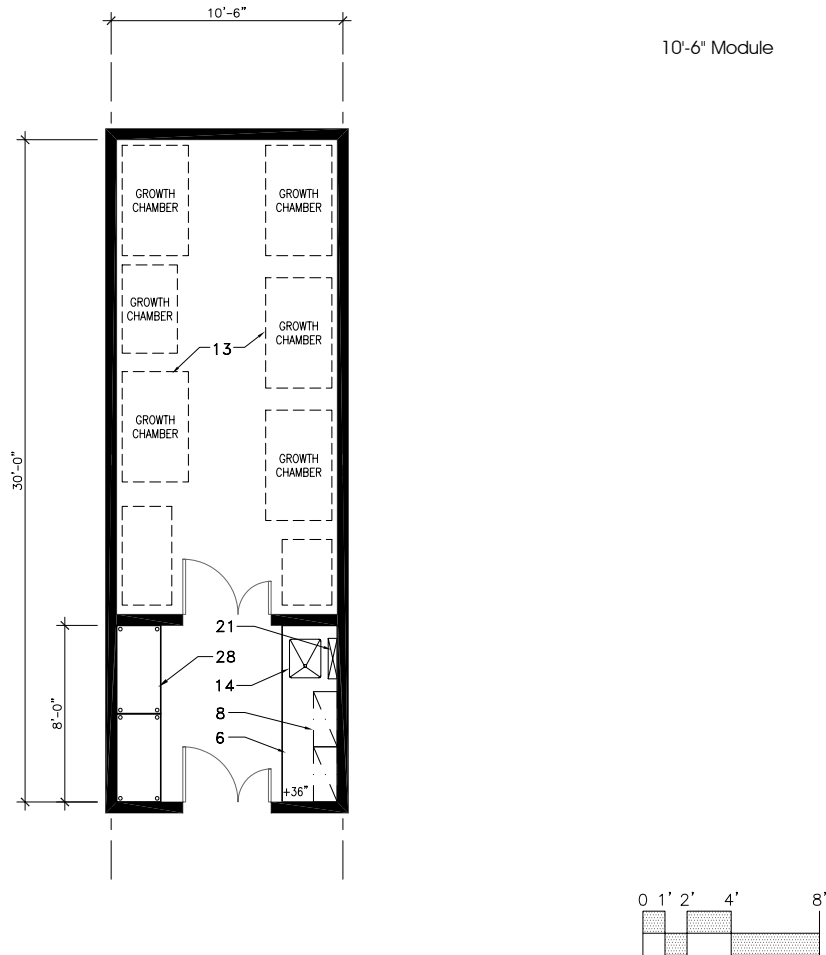

FURNISHINGS KEY

- | | | |
|--------------------------------------|----------------------------------|---|
| 1. Chemical Fume Hood | 13. Equipment Space | 25. Autoclave |
| 2. Biological Safety Cabinet | 14. Laboratory Sink | 26. Moveable Laboratory Table |
| 3. Radioisotope Hood | 15. Cupsink | 27. Wire Shelving |
| 4. Laminar Flow Hood | 16. Processing Sink | 28. Heavy Duty Shelving Unit |
| 5. Snorkel Exhaust | 17. Cylinder Rack | 29. White Markerboard |
| 6. Laboratory Bench, Standing Height | 18. Gas Cabinet | 30. Tackboard |
| 7. Laboratory Bench, Sitting Height | 19. Safety Shower/Eyewash | 31. Tech Desk |
| 8. Wall Cabinet | 20. Overhead Service Carrier | 32. Balance Table |
| 9. Adjustable Shelves | 21. Pipe Drop Enclosure | 33. Writing Table |
| 10. Reagent Shelves | 22. Moveable Demonstration Bench | 34. A/V Screen |
| 11. Tall Storage Cabinet | 23. Glassware Washer | 35. Multi-media Projector (Ceiling Mount) |
| 12. Vented Flammable Storage Cabinet | 24. Glassware Dryer | 36. File Cabinet |

DEPARTMENT: GENOMICS
SPACE NAME: INSECT REARING ROOM
INDEX NO.: 3.06
OCCUPANCY:



UTILIZATION

Hours of Use
 8 hours/day _____
 14 hours/day _____
 24 hours/day _____
 Hours of Operation
 8 hours/day _____
 14 hours/day _____
 24 hours/day _____

SECURITY

No Lock _____
 Keyed Lock _____
 Cardkey _____

MECHANICAL

Temperature
 72°F ± 2°F _____
 68°-90° ± 2°F _____
 Other _____
 Humidity
 50-70% ± 5% _____
 Ambient _____
 15 Air Changes/Hour _____
 8 to 10 Air Changes/Hour _____
 6 Air Changes/Hour _____
 100% Make-up Air Note 1.
 Recirculated Air _____
 Air Pressure Positive _____
 Air Pressure Negative _____
 Air Filtration/Supply _____

HOODS

Chemical Fume Hood _____
 Radioisotope Hood _____
 Laminar Flow Hood _____
 Biological Safety Cabinet (OFOI) _____
 Snorkel _____
 Canopy Hood _____
 Other _____

LABORATORY EQUIPMENT

Vibration Sensitive _____
 Light Sensitive _____
 Vibration Producing _____
 Heat Producing _____
 Noise Producing _____

PLUMBING

Laboratory Gas (LG) _____
 Laboratory Vacuum (LV) _____
 Laboratory Air (LA) _____
 Compressed Air, 100 psi (A) _____
 Industrial Hot Water (IHW) _____
 Industrial Cold Water (ICW) _____
 Potable Cold Water _____
 Potable Hot Water _____
 High Purity Water (DI) _____
 Chilled Water (CHW S/R) _____
 Carbon Dioxide (CO₂) _____
 Nitrogen Gas (N₂) _____
 Cylinder Gases _____
 Inert _____
 Flammable _____
 Toxic _____
 Floor Drain (FD) Note 2.
 Floor Sink (FS) _____
 Sediment Trap _____
 Safety Shower/Eyewash (SS) _____
 Hose bib _____

ELECTRICAL

110V, 20A, 1 Phase _____
 208V, 30A, 1 Phase _____
 208V, 30A, 3 Phase _____
 480V, 100A, 3 Phase _____
 Isolated Ground Outlet _____
 Emergency Power _____
 UPS (OFOI) _____
 Voice / Data _____
 In Use Light _____
 Task Lighting _____
 Lighting Level _____
 100 fc at bench/desk _____
 75 fc at bench/desk _____
 Safe light _____
 Special Lighting Note 3.
 Darkenable _____
 Zoned Lighting _____

CHEMICALS

Bases _____
 Acids _____
 Solvents _____
 Radioisotopes _____
 Carcinogens/Regulated _____
 Chemical Waste Storage _____
 Biological Storage _____
 Radioisotope Storage _____
 Chemical Storage _____

ARCHITECTURAL

Floor
 VCT (Chemical Resistant) _____
 VCT _____
 Welded Seam Sheet Vinyl _____
 Epoxy _____
 Carpet _____
 Low Static Carpet _____
 Sealed Concrete _____
 Partitions
 Gyp Board, Epoxy Paint _____
 Gyp Board, Paint _____
 Other _____
 Base
 4" Rubber _____
 Integral w/floor _____
 Ceiling
 Open _____
 Acoustic Tile _____
 Gyp Board, Epoxy Paint _____
 Height _____
 Doors
 3'-6" x 7' _____
 3' x 7' Note 4.
 1'-6" x 7' _____
 Light Tight Rotating Door _____
 Vision Panel _____
 Natural Daylight _____
ACOUSTICS
 Normal _____
 Privacy _____

REMARKS:

1. Filter on intake and exhaust (mesh size to be determined)
2. Sealed drain at floor
3. Outlets at ceiling for grow lights to be on timer with switch override.
4. Doors sealed with minimum threshold.
5. All penetrations to be sealed to prevent insect migration
6. Stainless steel top and sink
7. Painted steel casework

OWNER FURNISHED EQUIPMENT:

- a. Rearing racks and cages
- b.
- c.
- d.
- e.
- f.

DEPARTMENT: GENOMICS
SPACE NAME: INSECTORY
INDEX NO.: 3.06
AREA: 210 ASF



This diagram is conceptual and is provided only to indicate required furnishings, equipment, and general room proportions. The actual room design may change.

10'-6" Module

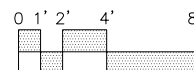
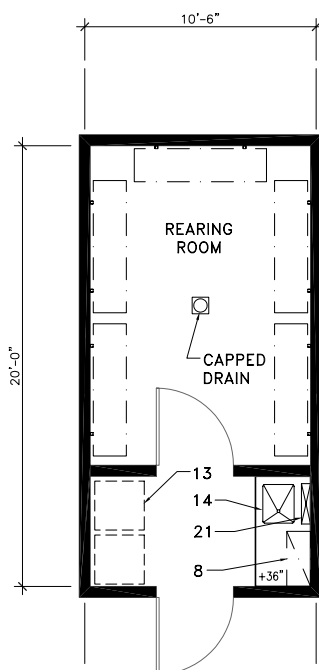

FURNISHINGS KEY

- | | | |
|--------------------------------------|----------------------------------|---|
| 1. Chemical Fume Hood | 13. Equipment Space | 25. Autoclave |
| 2. Biological Safety Cabinet | 14. Laboratory Sink | 26. Moveable Laboratory Table |
| 3. Radioisotope Hood | 15. Cupsink | 27. Wire Shelving |
| 4. Laminar Flow Hood | 16. Processing Sink | 28. Heavy Duty Shelving Unit |
| 5. Snorkel Exhaust | 17. Cylinder Rack | 29. White Markerboard |
| 6. Laboratory Bench, Standing Height | 18. Gas Cabinet | 30. Tackboard |
| 7. Laboratory Bench, Sitting Height | 19. Safety Shower/Eyewash | 31. Tech Desk |
| 8. Wall Cabinet | 20. Overhead Service Carrier | 32. Balance Table |
| 9. Adjustable Shelves | 21. Pipe Drop Enclosure | 33. Writing Table |
| 10. Reagent Shelves | 22. Moveable Demonstration Bench | 34. AV Screen |
| 11. Tall Storage Cabinet | 23. Glassware Washer | 35. Multi-media Projector (Ceiling Mount) |
| 12. Vented Flammable Storage Cabinet | 24. Glassware Dryer | 36. File Cabinet |

DEPARTMENT:
SPACE NAME:
INDEX NO.:
OCCUPANCY:

GENOMICS
ARABIDOPSIS CONTROLLED TEMPERATURE ROOM
3.07



UTILIZATION

Hours of Use
 8 hours/day _____
 14 hours/day _____
 24 hours/day _____
 Hours of Operation
 8 hours/day _____
 14 hours/day _____
 24 hours/day _____

SECURITY

No Lock _____
 Keyed Lock _____
 Cardkey _____

MECHANICAL

Temperature
 72°F ± 2°F _____
 68°-75° ± 2°F _____
 Other Note 2. _____
 Humidity
 50-70% ± 5% _____
 Ambient _____

15 Air Changes/Hour _____
 8 to 10 Air Changes/Hour _____
 6 Air Changes/Hour _____
 100% Make-up Air _____
 Recirculated Air _____
 Air Pressure Positive _____
 Air Pressure Negative _____
 Air Filtration/Supply _____

HOODS

Chemical Fume Hood _____
 Radioisotope Hood _____
 Laminar Flow Hood _____
 Biological Safety Cabinet (OFOI) _____
 Snorkel _____
 Canopy Hood _____
 Other _____

LABORATORY EQUIPMENT

Vibration Sensitive _____
 Light Sensitive _____
 Vibration Producing _____
 Heat Producing _____
 Noise Producing _____

PLUMBING

Laboratory Gas (LG) _____
 Laboratory Vacuum (LV) _____
 Laboratory Air (LA) _____
 Compressed Air, 100 psi (A) _____
 Industrial Hot Water (IHW) _____
 Industrial Cold Water (ICW) _____
 Potable Cold Water _____
 Potable Hot Water _____
 High Purity Water (DI) _____
 Chilled Water (CHW S/R) _____
 Carbon Dioxide (CO₂) _____
 Nitrogen Gas (N₂) _____
 Cylinder Gases
 Inert _____
 Flammable _____
 Toxic _____

Floor Drain (FD) _____
 Floor Sink (FS) _____
 Sediment Trap _____
 Safety Shower/Eyewash (SS) _____
 Drench Hose (DH) _____

ELECTRICAL

110V, 20A, 1 Phase _____
 208V, 30A, 1 Phase _____
 208V, 30A, 3 Phase _____
 480V, 100A, 3 Phase _____
 Isolated Ground Outlet _____
 Emergency Power _____
 UPS (OFOI) _____
 Voice / Data _____
 In Use Light _____
 Task Lighting _____
 Lighting Level
 100 fc at bench/desk _____
 75 fc at bench/desk _____
 Safe light _____
 Special Lighting Note 1. _____
 Darkenable _____
 Zoned Lighting _____

CHEMICALS

Bases _____
 Acids _____
 Solvents _____
 Radioisotopes _____
 Carcinogens/Regulated _____
 Chemical Waste Storage _____
 Biological Storage _____
 Radioisotope Storage _____
 Chemical Storage _____

ARCHITECTURAL

Floor
 VCT (Chemical Resistant) _____
 VCT _____
 Welded Seam Sheet Vinyl _____
 Epoxy _____
 Carpet _____
 Low Static Carpet _____
 Insulated Panels _____
 Partitions
 Gyp Board, Epoxy Paint _____
 Gyp Board, Paint _____
 Insulated Panels _____

Base
 4" Rubber _____
 Integral w/floor _____
 Ceiling
 Insulated Panels _____
 Acoustic Tile _____
 Gyp Board, Epoxy Paint _____
 Height _____

Doors
 3'-6" x 7' _____
 3' x 7' _____
 1'-6" x 7' _____
 Light Tight Rotating Door _____
 Vision Panel _____
 Natural Daylight _____

ACOUSTICS

Normal _____
 Privacy _____

REMARKS:

1. Timer controlled growth lights at each rack shelf
2. 15°C to 40°C

OWNER FURNISHED EQUIPMENT:

- a. Growth Racks (laminar flow)
- b. Racks

DEPARTMENT: GENOMICS
SPACE NAME: ARABIDOPSIS GROWTH ROOM
INDEX NO.: 3.07
AREA: 210 ASF



This diagram is conceptual and is provided only to indicate required furnishings, equipment, and general room proportions. The actual room design may change.

10'-6" Module

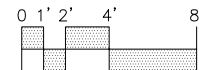
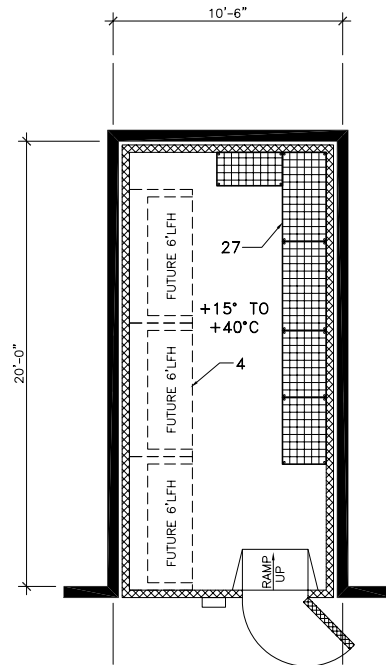

FURNISHINGS KEY

- | | | |
|--------------------------------------|----------------------------------|---|
| 1. Chemical Fume Hood | 13. Equipment Space | 25. Autoclave |
| 2. Biological Safety Cabinet | 14. Laboratory Sink | 26. Moveable Laboratory Table |
| 3. Radioisotope Hood | 15. Cupsink | 27. Wire Shelving |
| 4. Laminar Flow Hood | 16. Processing Sink | 28. Heavy Duty Shelving Unit |
| 5. Snorkel Exhaust | 17. Cylinder Rack | 29. White Markerboard |
| 6. Laboratory Bench, Standing Height | 18. Gas Cabinet | 30. Tackboard |
| 7. Laboratory Bench, Sitting Height | 19. Safety Shower/Eyewash | 31. Tech Desk |
| 8. Wall Cabinet | 20. Overhead Service Carrier | 32. Balance Table |
| 9. Adjustable Shelves | 21. Pipe Drop Enclosure | 33. Writing Table |
| 10. Reagent Shelves | 22. Moveable Demonstration Bench | 34. A/V Screen |
| 11. Tall Storage Cabinet | 23. Glassware Washer | 35. Multi-media Projector (Ceiling Mount) |
| 12. Vented Flammable Storage Cabinet | 24. Glassware Dryer | 36. File Cabinet |

DEPARTMENT: GENOMICS
SPACE NAME: CELL CULTURE LABORATORY
INDEX NO.: 3.08
OCCUPANCY:



UTILIZATION

Hours of Use
 8 hours/day _____
 14 hours/day _____
 24 hours/day
 Hours of Operation
 8 hours/day _____
 14 hours/day _____
 24 hours/day

SECURITY

No Lock _____
 Keyed Lock
 Cardkey _____

MECHANICAL

Temperature
 72°F ± 2°F _____
 68°-75° ± 2°F
 Other _____
 Humidity
 50% ± 20% _____
 Ambient

15 Air Changes/Hour _____
 8 to 10 Air Changes/Hour
 6 Air Changes/Hour _____
 100% Make-up Air
 Recirculated Air _____
 Air Pressure Positive
 Air Pressure Negative _____
 Air Filtration/Supply _____

HOODS

Chemical Fume Hood _____
 Radioisotope Hood _____
 Laminar Flow Hood _____
 Biological Safety Cabinet (OFOI) Note 1.
 Snorkel _____
 Canopy Hood _____
 Other _____

LABORATORY EQUIPMENT

Vibration Sensitive _____
 Light Sensitive _____
 Vibration Producing _____
 Heat Producing
 Noise Producing _____

PLUMBING

Laboratory Gas (LG)
 Laboratory Vacuum (LV)
 Laboratory Air (LA)
 Compressed Air, 100 psi (A) _____
 Industrial Hot Water (IHW)
 Industrial Cold Water (ICW)
 Potable Cold Water _____
 Potable Hot Water _____
 High Purity Water (DI)
 Chilled Water (CHW S/R) _____
 Carbon Dioxide (CO₂)
 Nitrogen Gas (N₂) _____
 Cylinder Gases _____
 Inert _____
 Flammable _____
 Toxic _____

Floor Drain (FD) _____
 Floor Sink (FS) _____
 Sediment Trap _____
 Safety Shower/Eyewash (SS)
 Drench Hose (DH)

ELECTRICAL

110V, 20A, 1 Phase
 208V, 30A, 1 Phase _____
 208V, 30A, 3 Phase _____
 480V, 100A, 3 Phase _____
 Isolated Ground Outlet
 Emergency Power
 UPS (OFOI) _____
 Voice / Data
 In Use Light _____
 Task Lighting _____
 Lighting Level _____
 50-60 fc direct/indirect
 75 fc at bench/desk _____
 Safe light _____
 Special Lighting _____
 Darkenable _____
 Zoned Lighting _____

CHEMICALS

Bases _____
 Acids _____
 Solvents _____
 Radioisotopes _____
 Carcinogens/Regulated _____
 Chemical Waste Storage _____
 Biological Storage
 Radioisotope Storage _____
 Chemical Storage _____

ARCHITECTURAL

Floor
 VCT (Chemical Resistant) _____
 VCT _____
 Welded Seam Sheet Vinyl
 Epoxy _____
 Carpet _____
 Low Static Carpet _____
 Sealed Concrete _____
 Partitions
 Gyp Board, Epoxy Paint
 Gyp Board, Paint _____
 Other _____

Base
 4" Rubber _____
 Integral w/floor
 Ceiling
 Open _____
 Rigid vinyl tile
 Gyp Board, Epoxy Paint _____
 Height 9' min.

Doors
 3'-6" x 7'
 3' x 7' _____
 1'-6" x 7' _____
 Light Tight Rotating Door _____
 Vision Panel
 Natural Daylight _____

ACOUSTICS

Normal
 Privacy _____

REMARKS:

1. (2) 4' BSCs + (1) 6' BSC - all Type II A1/A2 - OFOI
2. Epoxy resin tops
3. Epoxy resin drop-in sinks
4. Maple casework with clear finish

OWNER FURNISHED EQUIPMENT:

- a. Refrigerator
- b. Incubators
- c. Microscope
- d.

DEPARTMENT: GENOMICS
SPACE NAME: CELL CULTURE ROOM - OPTIONS A & B
INDEX NO.: 3.08
AREA: 210 ASF



This diagram is conceptual and is provided only to indicate required furnishings, equipment, and general room proportions. The actual room design may change.

10'-6" Module

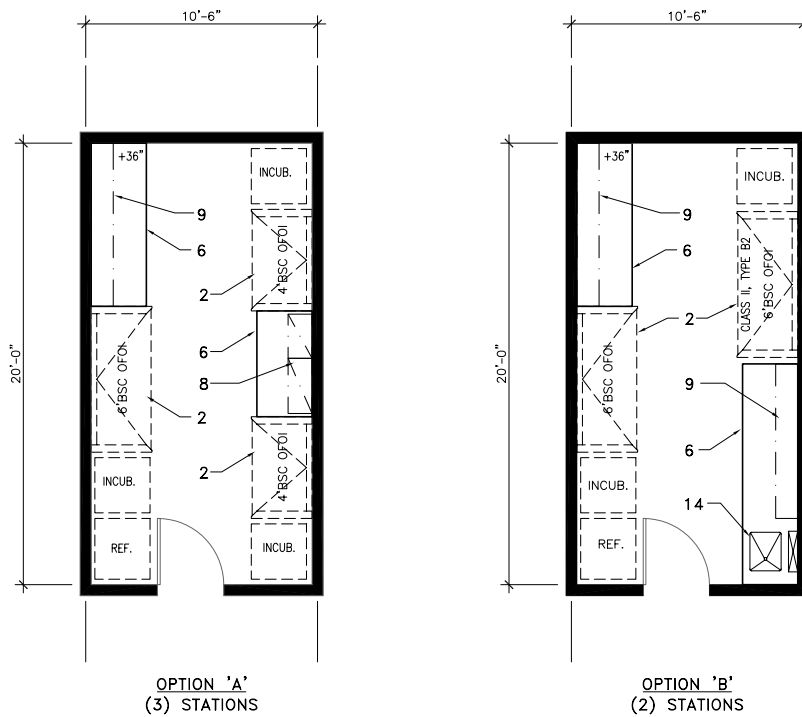

FURNISHINGS KEY

- | | | |
|--------------------------------------|----------------------------------|---|
| 1. Chemical Fume Hood | 13. Equipment Space | 25. Autoclave |
| 2. Biological Safety Cabinet | 14. Laboratory Sink | 26. Moveable Laboratory Table |
| 3. Radioisotope Hood | 15. Cupshk | 27. Wire Shelving |
| 4. Laminar Flow Hood | 16. Processing Sink | 28. Heavy Duty Shelving Unit |
| 5. Snorkel Exhaust | 17. Cylinder Rack | 29. White Markerboard |
| 6. Laboratory Bench, Standing Height | 18. Gas Cabinet | 30. Tackboard |
| 7. Laboratory Bench, Sitting Height | 19. Safety Shower/Eyewash | 31. Tech Desk |
| 8. Wall Cabinet | 20. Overhead Service Carrier | 32. Balance Table |
| 9. Adjustable Shelves | 21. Pipe Drop Enclosure | 33. Writing Table |
| 10. Reagent Shelves | 22. Moveable Demonstration Bench | 34. AV Screen |
| 11. Tall Storage Cabinet | 23. Glassware Washer | 35. Multi-media Projector (Ceiling Mount) |
| 12. Vented Flammable Storage Cabinet | 24. Glassware Dryer | 36. File Cabinet |

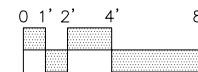

DEPARTMENT: GENOMICS
SPACE NAME: FUME HOOD ALCOVE
INDEX NO.: 3.09
OCCUPANCY:



UTILIZATION

Hours of Use
 8 hours/day _____
 14 hours/day _____
 24 hours/day _____
 Hours of Operation
 8 hours/day _____
 14 hours/day _____
 24 hours/day _____

SECURITY

No Lock _____
 Keyed Lock _____
 Cardkey _____

MECHANICAL

Temperature
 72°F ± 2°F _____
 68°-75° ± 2°F _____
 Other _____
 Humidity
 50% ± 20% _____
 Ambient _____

15 Air Changes/Hour _____
 8 to 10 Air Changes/Hour _____
 6 Air Changes/Hour _____
 100% Make-up Air _____
 Recirculated Air _____
 Air Pressure Positive _____
 Air Pressure Negative _____
 Air Filtration/Supply _____

HOODS

Chemical Fume Hood Note 1. _____
 Radioisotope Hood _____
 Laminar Flow Hood _____
 Biological Safety Cabinet (OFOI) _____
 Snorkel _____
 Canopy Hood _____
 Other _____

LABORATORY EQUIPMENT

Vibration Sensitive _____
 Light Sensitive _____
 Vibration Producing _____
 Heat Producing _____
 Noise Producing _____

PLUMBING

Laboratory Gas (LG) _____
 Laboratory Vacuum (LV) _____
 Laboratory Air (LA) _____
 Compressed Air, 100 psi (A) _____
 Industrial Hot Water (IHW) _____
 Industrial Cold Water (ICW) _____
 Potable Cold Water _____
 Potable Hot Water _____
 High Purity Water (DI) _____
 Chilled Water (CHW S/R) _____
 Carbon Dioxide (CO₂) _____
 Nitrogen Gas (N₂) _____
 Cylinder Gases _____
 Inert _____
 Flammable _____
 Toxic _____
 Floor Drain (FD) _____
 Floor Sink (FS) _____
 Sediment Trap _____
 Safety Shower/Eyewash (SS) _____
 Drench Hose (DH) _____

ELECTRICAL

110V, 20A, 1 Phase _____
 208V, 30A, 1 Phase _____
 208V, 30A, 3 Phase _____
 480V, 100A, 3 Phase _____
 Isolated Ground Outlet _____
 Emergency Power _____
 UPS (OFOI) _____
 Voice / Data _____
 In Use Light _____
 Task Lighting _____
 Lighting Level _____
 50-60 fc direct/indirect _____
 75 fc at bench/desk _____
 Safe light _____
 Special Lighting _____
 Darkenable _____
 Zoned Lighting _____

CHEMICALS

Bases _____
 Acids _____
 Solvents _____
 Radioisotopes _____
 Carcinogens/Regulated _____
 Chemical Waste Storage _____
 Biological Storage _____
 Radioisotope Storage _____
 Chemical Storage _____

ARCHITECTURAL

Floor
 VCT (Chemical Resistant) _____
 VCT _____
 Welded Seam Sheet Vinyl _____
 Epoxy _____
 Carpet _____
 Low Static Carpet _____
 Sealed Concrete _____
 Partitions
 Gyp Board, Epoxy Paint _____
 Gyp Board, Paint _____
 Other _____
 Base
 4" Rubber _____
 Integral w/floor _____
 Ceiling
 Open _____
 Acoustic Tile _____
 Gyp Board, Epoxy Paint _____
 Height 9' min. _____
 Doors
 3'-6" x 7' _____
 3' x 7' _____
 1'-6" x 7' _____
 Light Tight Rotating Door _____
 Vision Panel _____
 Natural Daylight _____
ACOUSTICS
 Normal _____
 Privacy _____

REMARKS:

1. (1) 6' CFH (total of 27 - 6' CFHs in budget)
2. Fume hoods shall have proximity sensors
3. Fume hood controls shall communicate with the buildings EMS
4. Epoxy resin tops
5. Epoxy resin drop-in sinks
6. Maple casework with clear finish

OWNER FURNISHED EQUIPMENT:

- a.
- b.
- c.
- d.
- e.
- f.

DEPARTMENT: GENOMICS
SPACE NAME: FUME HOOD ALCOVE
INDEX NO.: 3.09
AREA: 84 ASF



This diagram is conceptual and is provided only to indicate required furnishings, equipment, and general room proportions. The actual room design may change.

10'-6" Module

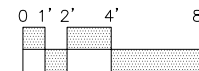
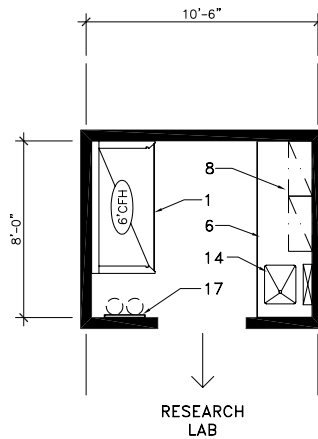

FURNISHINGS KEY

- | | | |
|--------------------------------------|----------------------------------|---|
| 1. Chemical Fume Hood | 13. Equipment Space | 25. Autoclave |
| 2. Biological Safety Cabinet | 14. Laboratory Sink | 26. Moveable Laboratory Table |
| 3. Radioisotope Hood | 15. Cupsink | 27. Wire Shelving |
| 4. Laminar Flow Hood | 16. Processing Sink | 28. Heavy Duty Shelving Unit |
| 5. Snorkel Exhaust | 17. Cylinder Rack | 29. White Markerboard |
| 6. Laboratory Bench, Standing Height | 18. Gas Cabinet | 30. Tackboard |
| 7. Laboratory Bench, Sitting Height | 19. Safety Shower/Eyewash | 31. Tech Desk |
| 8. Wall Cabinet | 20. Overhead Service Carrier | 32. Balance Table |
| 9. Adjustable Shelves | 21. Pipe Drop Enclosure | 33. Writing Table |
| 10. Reagent Shelves | 22. Moveable Demonstration Bench | 34. A/V Screen |
| 11. Tall Storage Cabinet | 23. Glassware Washer | 35. Multi-media Projector (Ceiling Mount) |
| 12. Vented Flammable Storage Cabinet | 24. Glassware Dryer | 36. File Cabinet |

DEPARTMENT:
SPACE NAME:
INDEX NO.:
OCCUPANCY:

GENOMICS
CLUSTER FARM ROOM (BIOINFORMATICS)
3.10



UTILIZATION

Hours of Use
 8 hours/day _____
 14 hours/day _____
 24 hours/day
 Hours of Operation
 8 hours/day _____
 14 hours/day _____
 24 hours/day

SECURITY

No Lock _____
 Keyed Lock
 Cardkey _____

MECHANICAL

Temperature
 72°F ± 2°F _____
 68°-75° ± 2°F
 Other _____
 Humidity
 50% ± 20% _____
 Ambient

15 Air Changes/Hour Note 4.
 8 to 10 Air Changes/Hour _____
 6 Air Changes/Hour _____
 100% Make-up Air _____
 Recirculated Air
 Air Pressure Positive _____
 Air Pressure Negative
 Air Filtration/Supply _____

HOODS

Chemical Fume Hood _____
 Radioisotope Hood _____
 Laminar Flow Hood _____
 Biological Safety Cabinet (OFOI) _____
 Snorkel _____
 Canopy Hood _____
 Other _____

LABORATORY EQUIPMENT

Vibration Sensitive _____
 Light Sensitive _____
 Vibration Producing _____
 Heat Producing
 Noise Producing _____

REMARKS:

1. Plastic laminate tops
2. Raised Floor
3. 2 Liebert-type floor units
4. Air could be recirculated within this room
5. Fire suppression - see criteria
6. Refer to design criteria and cost plan for details

PLUMBING

Laboratory Gas (LG) _____
 Laboratory Vacuum (LV) _____
 Laboratory Air (LA) _____
 Compressed Air, 100 psi (A) _____
 Industrial Hot Water (IHW) _____
 Industrial Cold Water (ICW) _____
 Potable Cold Water _____
 Potable Hot Water _____
 High Purity Water (DI) _____
 Chilled Water (CHW S/R) _____
 Carbon Dioxide (CO₂) _____
 Nitrogen Gas (N₂) _____
 Cylinder Gases
 Inert _____
 Flammable _____
 Toxic _____
 Floor Drain (FD) _____
 Floor Sink (FS) _____
 Sediment Trap _____
 Safety Shower/Eyewash (SS) _____
 Drench Hose (DH) _____

ELECTRICAL

110V, 20A, 1 Phase
 208V, 30A, 1 Phase _____
 208V, 30A, 3 Phase _____
 480V, 100A, 3 Phase _____
 Isolated Ground Outlet _____
 Emergency Power
 UPS (OFOI)
 Voice / Data
 In Use Light _____
 Task Lighting _____
 Lighting Level
 50-60 fc direct/indirect
 75 fc at bench/desk _____
 Safe light _____
 Special Lighting _____
 Darkenable _____
 Zoned Lighting _____

CHEMICALS

Bases _____
 Acids _____
 Solvents _____
 Radioisotopes _____
 Carcinogens/Regulated _____
 Chemical Waste Storage _____
 Biological Storage _____
 Radioisotope Storage _____
 Chemical Storage _____

ARCHITECTURAL

Floor
 VCT (Chemical Resistant) _____
 VCT (static dissipating) on RF
 Welded Seam Sheet Vinyl _____
 Epoxy _____
 Carpet _____
 Low Static Carpet _____
 Sealed Concrete _____
 Partitions
 Gyp Board, Epoxy Paint _____
 Gyp Board, Paint
 Other _____
 Base
 4" Rubber
 Integral w/floor _____
 Ceiling
 Open _____
 Acoustic Tile
 Gyp Board, Epoxy Paint _____
 Height 9' min.
 Doors
 3'-6" x 7' _____
 3' x 7'
 1'-6" x 7' _____
 Light Tight Rotating Door _____
 Vision Panel
 Natural Daylight _____
ACOUSTICS
 Normal
 Privacy _____

OWNER FURNISHED EQUIPMENT:

- a. (30 to 50) CPUs
- b. Approximately 250 CPUS
- c. UPS
- d.
- e.
- f.

DEPARTMENT: **GENOMICS**
 SPACE NAME: **CLUSTER FARM ROOM (BIOINFORMATICS)**
 INDEX NO.: **3.10**
 AREA: **500 ASF**



This diagram is conceptual and is provided only to indicate required furnishings, equipment, and general room proportions. The actual room design may change.

10'-6" Module

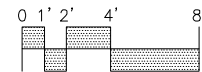
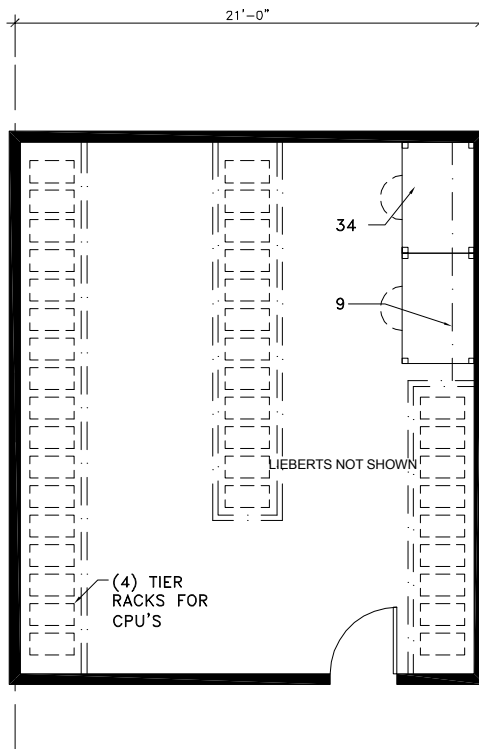

FURNISHINGS KEY

- | | | |
|--------------------------------------|----------------------------------|---|
| 1. Chemical Fume Hood | 13. Equipment Space | 25. Autoclave |
| 2. Biological Safety Cabinet | 14. Laboratory Sink | 26. Moveable Laboratory Table |
| 3. Radioisotope Hood | 15. Cupsink | 27. Wire Shelving |
| 4. Laminar Flow Hood | 16. Processing Sink | 28. Heavy Duty Shelving Unit |
| 5. Snorkel Exhaust | 17. Cylinder Rack | 29. White Markerboard |
| 6. Laboratory Bench, Standing Height | 18. Gas Cabinet | 30. Tackboard |
| 7. Laboratory Bench, Sitting Height | 19. Safety Shower/Eyewash | 31. Tech Desk |
| 8. Wall Cabinet | 20. Overhead Service Carrier | 32. Balance Table |
| 9. Adjustable Shelves | 21. Pipe Drop Enclosure | 33. Writing Table |
| 10. Reagent Shelves | 22. Moveable Demonstration Bench | 34. A/V Screen |
| 11. Tall Storage Cabinet | 23. Glassware Washer | 35. Multi-media Projector (Ceiling Mount) |
| 12. Vented Flammable Storage Cabinet | 24. Glassware Dryer | 36. File Cabinet |

DEPARTMENT:
SPACE NAME:
INDEX NO.:
OCCUPANCY:

GENOMICS
CONTROLLED TEMPERATURE ROOM (+4oC)
3.11



UTILIZATION

Hours of Use
 8 hours/day _____
 14 hours/day _____
 24 hours/day _____
 Hours of Operation
 8 hours/day _____
 14 hours/day _____
 24 hours/day _____

SECURITY

No Lock _____
 Keyed Lock _____
 Cardkey _____

MECHANICAL

Temperature
 72°F ± 2°F _____
 68°-75° ± 2°F _____
 Other _____
 Humidity
 50-70% ± 5% _____
 Ambient _____

15 Air Changes/Hour _____
 8 to 10 Air Changes/Hour _____
 6 Air Changes/Hour _____
 100% Make-up Air _____
 Recirculated Air _____
 Air Pressure Positive _____
 Air Pressure Negative _____
 Air Filtration/Supply _____

HOODS

Chemical Fume Hood _____
 Radioisotope Hood _____
 Laminar Flow Hood _____
 Biological Safety Cabinet (OFOI) _____
 Snorkel _____
 Canopy Hood _____
 Other _____

LABORATORY EQUIPMENT

Vibration Sensitive _____
 Light Sensitive _____
 Vibration Producing _____
 Heat Producing _____
 Noise Producing _____

PLUMBING

Laboratory Gas (LG) _____
 Laboratory Vacuum (LV) _____
 Laboratory Air (LA) _____
 Compressed Air, 100 psi (A) _____
 Industrial Hot Water (IHW) _____
 Industrial Cold Water (ICW) _____
 Potable Cold Water _____
 Potable Hot Water _____
 High Purity Water (DI) _____
 Chilled Water (CHW S/R) _____
 Carbon Dioxide (CO₂) _____
 Nitrogen Gas (N₂) _____
 Cylinder Gases
 Inert _____
 Flammable _____
 Toxic _____
 Floor Drain (FD) _____
 Floor Sink (FS) _____
 Sediment Trap _____
 Safety Shower/Eyewash (SS) _____
 Drench Hose (DH) _____

ELECTRICAL

110V, 20A, 1 Phase _____
 208V, 30A, 1 Phase _____
 208V, 30A, 3 Phase _____
 480V, 100A, 3 Phase _____
 Isolated Ground Outlet _____
 Emergency Power _____
 UPS (OFOI) _____
 Voice / Data _____
 In Use Light _____
 Task Lighting _____
 Lighting Level
 100 fc at bench/desk _____
 75 fc at bench/desk _____
 Safe light _____
 Special Lighting _____
 Darkenable _____
 Zoned Lighting _____

CHEMICALS

Bases _____
 Acids _____
 Solvents _____
 Radioisotopes _____
 Carcinogens/Regulated _____
 Chemical Waste Storage _____
 Biological Storage _____
 Radioisotope Storage _____
 Chemical Storage _____

ARCHITECTURAL

Floor
 VCT (Chemical Resistant) _____
 VCT _____
 Welded Seam Sheet Vinyl _____
 Epoxy _____
 Carpet _____
 Low Static Carpet _____
 Insulated Panels _____
 Partitions
 Gyp Board, Epoxy Paint _____
 Gyp Board, Paint _____
 Insulated Panels _____
 Base
 4" Rubber _____
 Integral w/floor _____
 Ceiling
 Insulated Panels _____
 Acoustic Tile _____
 Gyp Board, Epoxy Paint _____
 Height _____
 Doors
 3'-6" x 7' _____
 3' x 7' _____
 1'-6" x 7' _____
 Light Tight Rotating Door _____
 Vision Panel _____
 Natural Daylight _____
ACOUSTICS
 Normal _____
 Privacy _____

REMARKS:

1. Stainless steel tops
2. Stainless steel sinks

OWNER FURNISHED EQUIPMENT:

- a. Wire Storage Racks
- b.

DEPARTMENT: GENOMICS
SPACE NAME: +4°C COLD ROOM
INDEX NO.: 3.11
AREA: 119 ASF



This diagram is conceptual and is provided only to indicate required furnishings, equipment, and general room proportions. The actual room design may change.

10'-6" Module

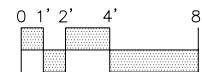
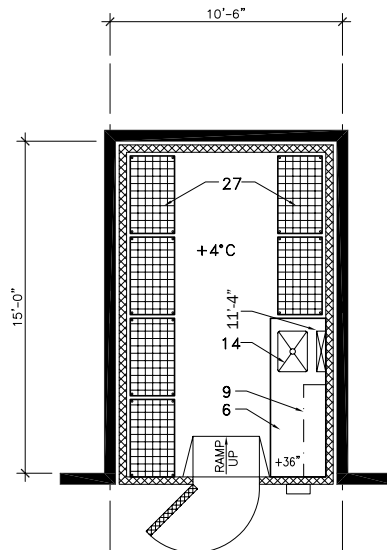

FURNISHINGS KEY

- | | | |
|--------------------------------------|----------------------------------|---|
| 1. Chemical Fume Hood | 13. Equipment Space | 25. Autoclave |
| 2. Biological Safety Cabinet | 14. Laboratory Sink | 26. Moveable Laboratory Table |
| 3. Radioisotope Hood | 15. Cupsink | 27. Wire Shelving |
| 4. Laminar Flow Hood | 16. Processing Sink | 28. Heavy Duty Shelving Unit |
| 5. Snorkel Exhaust | 17. Cylinder Rack | 29. White Markerboard |
| 6. Laboratory Bench, Standing Height | 18. Gas Cabinet | 30. Tackboard |
| 7. Laboratory Bench, Sitting Height | 19. Safety Shower/Eyewash | 31. Tech Desk |
| 8. Wall Cabinet | 20. Overhead Service Carrier | 32. Balance Table |
| 9. Adjustable Shelves | 21. Pipe Drop Enclosure | 33. Writing Table |
| 10. Reagent Shelves | 22. Moveable Demonstration Bench | 34. A/V Screen |
| 11. Tall Storage Cabinet | 23. Glassware Washer | 35. Multi-media Projector (Ceiling Mount) |
| 12. Vented Flammable Storage Cabinet | 24. Glassware Dryer | 36. File Cabinet |



DEPARTMENT: GENOMICS
SPACE NAME: CRYOGENIC STORAGE
INDEX NO.: 3.12
OCCUPANCY:

UTILIZATION

Hours of Use
 8 hours/day _____
 14 hours/day
 24 hours/day _____
 Hours of Operation
 8 hours/day _____
 14 hours/day
 24 hours/day _____

SECURITY

No Lock _____
 Keyed Lock
 Cardkey _____

MECHANICAL

Temperature
 72°F ± 2°F _____
 68°-75° ± 2°F
 Other _____
 Humidity
 50% ± 20% _____
 Ambient
 15 Air Changes/Hour _____
 8 to 10 Air Changes/Hour _____

6 Air Changes/Hour
 100% Make-up Air
 Recirculated Air _____
 Air Pressure Positive _____
 Air Pressure Negative
 Air Filtration/Supply _____

HOODS

Chemical Fume Hood _____
 Radioisotope Hood _____
 Laminar Flow Hood _____
 Biological Safety Cabinet (OFOI) _____
 Snorkel _____
 Canopy Hood _____
 Other _____

LABORATORY EQUIPMENT

Vibration Sensitive _____
 Light Sensitive _____
 Vibration Producing _____
 Heat Producing _____
 Noise Producing _____

PLUMBING

Laboratory Gas (LG) _____
 Laboratory Vacuum (LV) _____
 Laboratory Air (LA) _____
 Compressed Air, 100 psi (A) _____
 Industrial Hot Water (IHW) _____
 Industrial Cold Water (ICW) _____
 Potable Cold Water _____
 Potable Hot Water _____
 High Purity Water (DI) _____
 Chilled Water (CHW S/R) _____
 Carbon Dioxide (CO₂) _____
 Nitrogen Gas (N₂) _____
 Cylinder Gases
 Inert _____
 Flammable _____
 Toxic _____

Floor Drain (FD) _____
 Floor Sink (FS) _____
 Sediment Trap _____
 Safety Shower/Eyewash (SS) _____
 Drench Hose (DH) _____

ELECTRICAL

110V, 20A, 1 Phase
 208V, 30A, 1 Phase
 208V, 30A, 3 Phase _____
 480V, 100A, 3 Phase _____
 Isolated Ground Outlet _____
 Emergency Power
 UPS (OFOI) _____
 Voice / Data
 In Use Light _____
 Task Lighting _____
 Lighting Level
 50-60 fc direct/indirect
 75 fc at bench/desk _____
 Safe light _____
 Special Lighting _____
 Darkenable _____
 Zoned Lighting _____

CHEMICALS

Bases _____
 Acids _____
 Solvents _____
 Radioisotopes _____
 Carcinogens/Regulated _____
 Chemical Waste Storage _____
 Biological Storage
 Radioisotope Storage _____
 Chemical Storage _____

ARCHITECTURAL

Floor
 VCT (Chemical Resistant) _____
 VCT _____
 Welded Seam Sheet Vinyl
 Epoxy _____
 Carpet _____
 Low Static Carpet _____
 Sealed Concrete _____
 Partitions
 Gyp Board, Epoxy Paint _____
 Gyp Board, Paint
 Other _____

Base
 4" Rubber _____
 Integral w/floor
 Ceiling
 Open _____
 Acoustic Tile
 Gyp Board, Epoxy Paint _____
 Height 9' min.

Doors
 3'-6" x 7'
 3' x 7' _____
 1'-6" x 7' _____
 Light Tight Rotating Door _____
 Vision Panel
 Natural Daylight _____

ACOUSTICS

Normal
 Privacy _____

REMARKS:

- 1.
- 2.

OWNER FURNISHED EQUIPMENT:

- a. Cryo Freezers
- b. Liquid Nitrogen Dewers

DEPARTMENT: GENOMICS
SPACE NAME: CRYOGENIC STORAGE
INDEX NO.: 3.12
AREA: 105 ASF



This diagram is conceptual and is provided only to indicate required furnishings, equipment, and general room proportions. The actual room design may change.

10'-6" Module

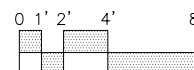
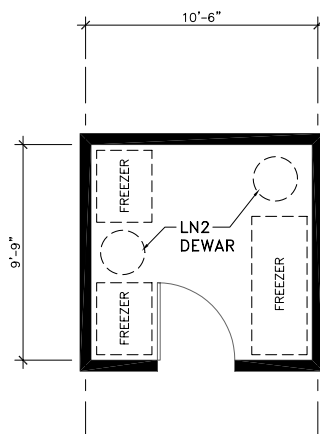

FURNISHINGS KEY

- | | | |
|--------------------------------------|----------------------------------|---|
| 1. Chemical Fume Hood | 13. Equipment Space | 25. Autoclave |
| 2. Biological Safety Cabinet | 14. Laboratory Sink | 26. Moveable Laboratory Table |
| 3. Radioisotope Hood | 15. Cupsink | 27. Wire Shelving |
| 4. Laminar Flow Hood | 16. Processing Sink | 28. Heavy Duty Shelving Unit |
| 5. Snorkel Exhaust | 17. Cylinder Rack | 29. White Markerboard |
| 6. Laboratory Bench, Standing Height | 18. Gas Cabinet | 30. Tackboard |
| 7. Laboratory Bench, Sitting Height | 19. Safety Shower/Eyewash | 31. Tech Desk |
| 8. Wall Cabinet | 20. Overhead Service Carrier | 32. Balance Table |
| 9. Adjustable Shelves | 21. Pipe Drop Enclosure | 33. Writing Table |
| 10. Reagent Shelves | 22. Moveable Demonstration Bench | 34. A/V Screen |
| 11. Tall Storage Cabinet | 23. Glassware Washer | 35. Multi-media Projector (Ceiling Mount) |
| 12. Vented Flammable Storage Cabinet | 24. Glassware Dryer | 36. File Cabinet |

4.0 Site Analysis

4.1 Campus Planning Context



The proposed site for the Genomics Building is located next to and north of Entomology I, and is within the College of Natural and Agricultural Sciences (CNAS) Precinct. On the north side of the site is Eucalyptus Drive, with Biological Science building just beyond. On the west edge is Citrus Drive, and on the east is the proposed extension of a pedestrian mall.

Building proposals must be consistent with the LRDP land use patterns and must be individually approved after review by the Chancellor, the UC Office of the President, and the Regents.

4.2 LRDP Goals

The summary of the LRDP goals that apply to the Genomics Building include the following:

- Continue to develop academic excellence in teaching, research and public service.
- Continue to develop a theme of entering main campus areas and buildings through arcades, porticos, vestibules, courtyards, and terraces.
- Maintain a cohesive framework of landscape malls and walkways to tie together campus land uses and academic precincts.
- Strengthen and clarify vehicular, bicycle, and pedestrian circulation patterns.
- Separate service and utility areas from major pedestrian entries.

The LRDP identifies the site as being within the CNAS Precinct. The proposed project is in compliance with the LRDP land use designation.

4.3 Site

This site and four other sites (Parking Lot #9, and three sites with greenhouses on East Campus Drive) were evaluated in the design process. Site (A) was clearly the best suited for the Genomics Building (see Appendix A). The site area is approximately 75,000 sf, or about 1.7 acres, and there is a grade differential of approximately 20 feet from the high point at the southeast corner to the low point at the northwest corner. Paved parking, lawn, and the Entomology Annex greenhouse occupy the site. Eucalyptus and pines are generally placed between the parking modules, and two large deciduous trees are located west of the Entomology Annex.



View from northeast corner of site



View from Entomology



View from northwest corner of site



Entomology service area

Air Quality Assessment and Wind Study

An air quality assessment report (dated March 2002) was prepared for the Biological Sciences Building and given to the team for evaluation. The analysis appears to have been conducted without including a structure on the site where the Genomics Building will be placed; therefore, a wind study should be conducted that is specific to the Genomics project.

4.4 Vehicular Circulation and Parking

The LRDP Vehicular Circulation Map shows Eucalyptus Drive as pedestrian, with limited access service in the future, providing access only for the campus shuttle, emergency and service vehicles. A portion of Citrus Drive north of the service for Entomology I is also shown to be limited access for vehicles. This agrees with a proposed traffic mitigation plan currently in draft stages. Confirmation on the status or acceptance of the traffic mitigation plan should be made at the next phase of development. Currently, both Citrus and Eucalyptus Drives are open to all vehicular traffic.

The LRDP identifies that existing parking spaces may be demolished for new buildings within the academic core, and new parking lots will be developed at the edges of the campus. The anticipated need for visitor parking to this building will be accommodated in the existing parking lot #9 to the west on East Campus Drive.

4.5 Pedestrian Circulation

The LRDP Pedestrian Circulation Map identifies important pedestrian walkways surrounding the site on the north, west and east. The Genomics Building provides an opportunity to emphasize the east-west and north-south pedestrian route from the Carillon Mall to new campus development to the south, and to create a more open access to Picnic Hill.

4.6 Utilities

The required services will include sewer, storm drain, potable water and fire protection. Natural gas, telecommunication, chilled water, steam and steam condensate will be served by a utility tunnel that originates from the campus central plant. The central chilled water plant is at or near capacity, and a satellite plant is currently under construction. The new plant will need to be operational prior to occupancy of the Genomics Building.

The sanitary sewer, storm drain and water service systems shall be designed in accordance with current engineering practices and all applicable Codes, Standards and Authorities having jurisdiction, including but not limited to the Uniform Plumbing Code, Riverside County Fire Department Standards, State Marshal Standards, Campus Fire Marshal, and University Design and Construction practice.

All existing buildings in the vicinity, such as Bioscience Labs, Entomology I and Boyden Labs, shall remain operational during demolition, removal, relocation and installation of all proposed site utilities.

An existing 12KV electrical line runs along Eucalyptus Drive, approximately 25 feet south of the southerly curb line. This line may require relocation based upon the final configuration of the building footprint. The construction of utility relocations and tie-ins shall be coordinated with UCR Office of Design and Construction.

Mechanical Utilities

All utilities referenced below will be routed from Eucalyptus Drive. The sizes for incoming/outgoing mechanical utilities are as follows:

- Chilled water supply and return (CHWS&R): 8" each
- High pressures (100 psig) steam (HPS (100)): 6"
- Pumped condensate: 2"

Site Sanitary Sewer System

There are two existing sanitary sewers in the vicinity of the site: an existing 8-inch sewer located at the northwest corner of the site flowing west in Eucalyptus Drive, an 8-inch line running north from Boyden Labs, and a sewer line of unidentified size running west from the Entomology Annex. The new sanitary sewer laterals will be routed north to Eucalyptus Drive. Piping material for the new laterals shall be PVC SDR 35, consistent with Campus Design and Construction practice.

Site Storm Drainage

There is a 10-inch storm drain along Eucalyptus Drive and a 12-inch storm drain along Citrus Drive. Runoff from the proposed building and associated site development shall be conveyed to these systems. Storm drain piping material shall be PVC SDR 35.

A storm water pollution prevention plan shall be prepared in accordance with the EPA's Storm Water Management for Construction Activities or local Erosion and Sedimentation Control standards and codes, whichever is more stringent. The plan shall show all Best Management Practices necessary to control and prevent soil loss during construction by storm water runoff and/or wind erosion, including protecting topsoil by stockpiling for reuse. A post-development storm water management plan will be prepared in an effort to minimize storm water runoff, increase on-site infiltration, and reduce runoff contaminants from discharging into the storm drain system. Storm water treatment systems will be designed to reduce the average annual post development total suspended solids and pollutants by installing mechanical or natural treatment systems, such as catch basin filter inserts, clarifiers and cistern subsurface infiltration changers, vegetated filter strips, and bioswales.

Domestic and Fire Water

There is a 12-inch main along Eucalyptus Drive and a 10-inch main along Citrus Drive. Domestic and fire water supply for the proposed building will be served from the 12-inch main along Eucalyptus Drive. All domestic and fire water service laterals will require backflow protection, in accordance with the UCR list of approved backflow prevention devices. The fire service line will require a Riverside Fire Department connection and post-indicator valve. All site water shall be PVC C900.

The UCR Fire Marshal believes that a new hydrant will be required on Citrus Drive across from the Genomics Building, which must be confirmed in the next phase of design.

Utility Tunnel

The majority of the academic buildings on campus have natural gas, steam and steam condensate, chilled water supply and return, supplied via a tunnel that originates in the central plant. Utilities to supply the new building can be extended underground from the tunnel that runs along Eucalyptus Drive.

4.7 Soils and Grading

A soils report and foundation recommendation was prepared for Entomology I in 1998 by CMJ Inc. (1355 E. Cooley Dr., Colton, CA 92324-3954) and it recommends that spread footings be used. Further soils testing and study for the site should be undertaken early in the next design phase of this building to confirm specific requirements.

4.8 Campus Service Group Issues

The Campus Service Groups were given a presentation for the proposed design and asked for input in the planning process. During the next stage of design, the Campus Service Groups will be consulted in more detail about their areas of responsibility. The LRDP and UCR Design Guidelines and the following general criteria will be met.

Physical Plant and Utilities

Systems shall follow the UCR Design Guidelines. Access should be maintained to major mechanical and electrical equipment. The design should maintain flexibility to accommodate changes in the use of the building. The East Campus Infrastructure Plan, completed in June 2002, has maps of existing utilities. Utility locations and sizes should be confirmed with the Office of Design and Construction, or Physical Plant.

Materials Management

Access must be maintained for service and deliveries to Entomology I. Door widths from the dock to the building, and building corridors, should be wide enough to accommodate large pieces of equipment.

Communications

Design and planning standards for communications will include adequate data outlets in the labs and offices. Provide four 4" conduits from the main telecom room to the steam tunnel vault, located at the NW corner of the University Lab Building. Refer to the following web page for campus standards:
http://www.cnc.ucr.edu/cs/comm_stand_7_2002R1V6.pdf

Emergency Vehicle Access

The campus has developed an approved plan for emergency vehicle access, and the proposed site has a designated emergency vehicle access route that must be maintained. All emergency vehicle access routes are to be kept open during and after construction.

Parking and Circulation

Service vehicle parking is included in this DPP at the loading docks only. Replacement parking for the existing lot, including handicapped parking, is included in this DPP. Parking will be replaced as part of a parking master plan and will be an indirect cost. The LRDP states when buildings replace parking within the academic core, new parking lots will be developed at the perimeter of the campus.

Special Services (Disabled Students and Staff)

Accessibility standards are to be met for this project. The Americans with Disabilities Act provides the standard guidelines used by the campus for accessibility. Design solutions for the site and building must follow guideline requirements for accessibility. A provision for accessible parking stalls will be made off-site, and will be accessible to the site.

Security

Provisions for security cameras and monitoring are addressed in this DPP. In addition to monitoring, the project will use the Campus Standard for swipe-card access throughout.

4.9 Site Analysis

The Planning Influences diagram below illustrates existing pedestrian and vehicular circulation, utility tunnels, and service and emergency vehicle access points impacting the site.

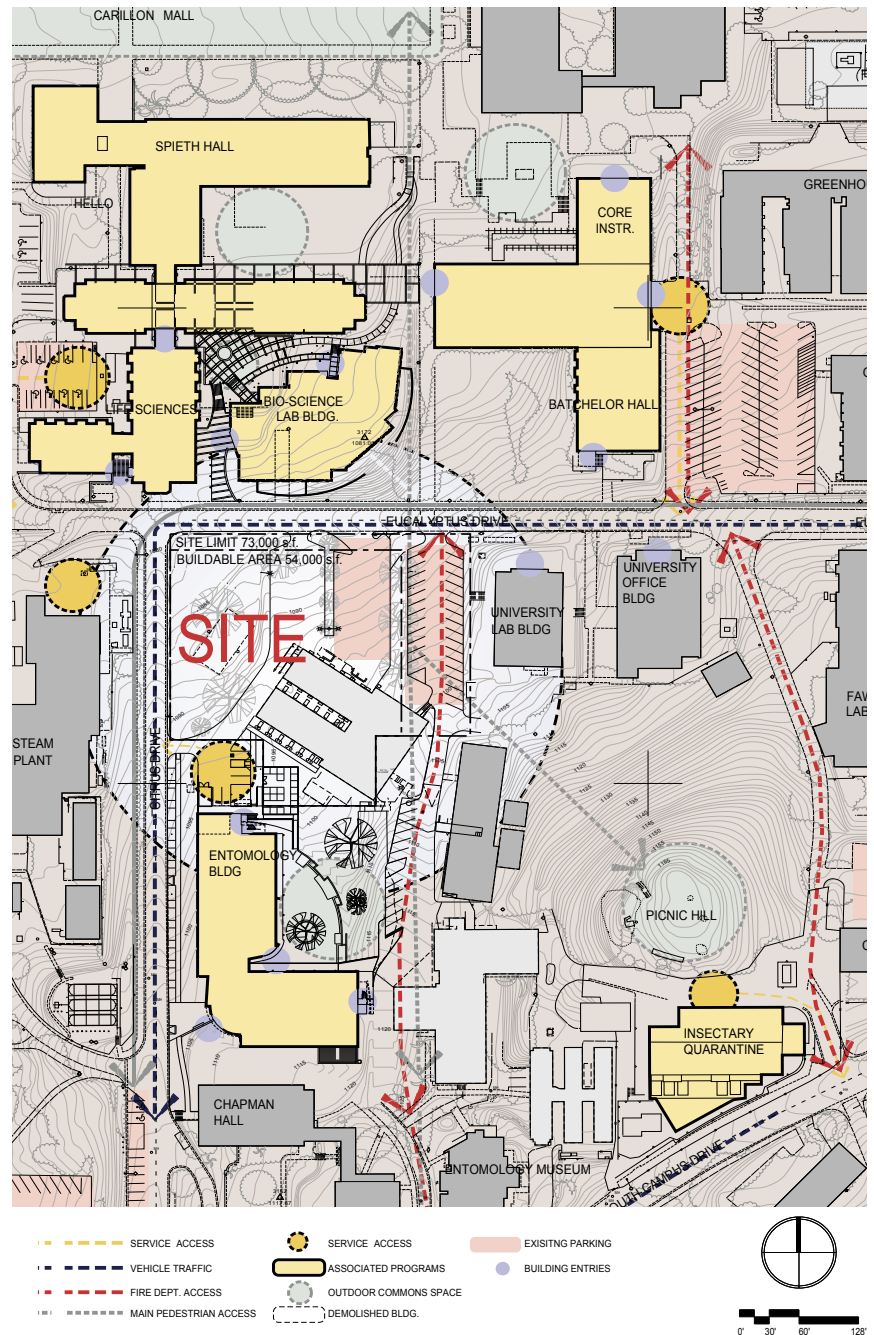

4.10 Site Planning Principles

The Committee adopted the following principles for the site:

- Annex structure will be removed summer 2004 for construction of Genomics.
- Parking lot #12 will be removed for extension of pedestrian mall.
- Utilities adjacent to the new Entomology service yard and serving the Annex and old Entomology will be removed to allow for Genomics.
- Scope of site development boundaries include Eucalyptus Drive, Citrus Drive, new Entomology service yard, and University lab; area approximately 75,000 sf/1.7 acres.
- Service for Genomics will be from existing/expanded Entomology service yard.
- Large conference room will be accessible from outside Genomics to encourage joint usage.

Pest Management/Genomics Complex Plan

- Old Entomology and Insectary Buildings will be removed in the near future—Boyden will eventually be removed.
- Campus pedestrian mall from the north will terminate at Entomology I—pedestrian connection will continue to AGSM.
- Parking within the zone will be limited to campus service vehicles only.
- Vehicular access will be limited to emergency vehicles and campus services.
- Future building capacity (beyond Genomics) is 125-200,000 gsf, depending on density and approach to open space.
- Future building will be located on the west side of Picnic Hill and east of Entomology I.

Campus

- Support the LRDP goals and principles.
- Integrate and extend the campus pedestrian circulation axis to the south.
- Provide access and visibility to Picnic Hill as a unique campus open space.
- Enhance the special quality of the UCR campus landscape and courtyards.
- Maintain continuity of campus architectural character, quality, scale and materials.
- Support campus infrastructure and service systems.

Genomics/CNAS

- Create an identity and center for genomics research.
- Facilitate collaboration with Bioscience, Entomology and Core Instrumentation, including shared spaces.
- Provide for future growth of the Genomics and Pest Management programs.
- Encourage interaction among faculty and students.
- Develop a creative and nurturing research environment.
- Create flexible space that can adapt to evolving research needs.

The key site planning principles that have been identified through the DPP process are the product of the site analysis, and they establish the criteria for planning and design.

Pedestrian Access

The majority of faculty and students will approach the building from the northeast corner of the site, from parking lot #9 on East Campus Drive. University pedestrian circulation is also from the north, from the Carillon Mall, and the areas around Webber, Boyce and Batchelor Halls, as well as from Biological Science to the north, across Eucalyptus Drive. This northeastern approach will bring faculty and students to the courtyard entrance. Secondary circulation is to the northwest corner from Biological Sciences and other lab buildings. The pedestrian circulation routes create opportunities for courtyards, plazas, and focal points.

Courtyards

The LRDP states that all new buildings will incorporate courtyards or terraces, which should function as outdoor rooms for individual buildings where people naturally gather, and which are near active areas such as entries. The character of the courtyard should relate to the specific building and should provide seating and shelter from winter winds and summer sun. Within the building footprint, there is an opportunity to create an internal courtyard that speaks to the function of the research that takes place and serves the occupants. The open courtyard space can be an agricultural demonstration space for the students and faculty. In addition, there are opportunities to create a hierarchy of private space to public, and from the courtyard out to more campus-oriented plazas that connect to the campus pedestrian path systems.

Service

The service zone will be shared with Entomology I, and will utilize the existing access driveway and service/delivery area.

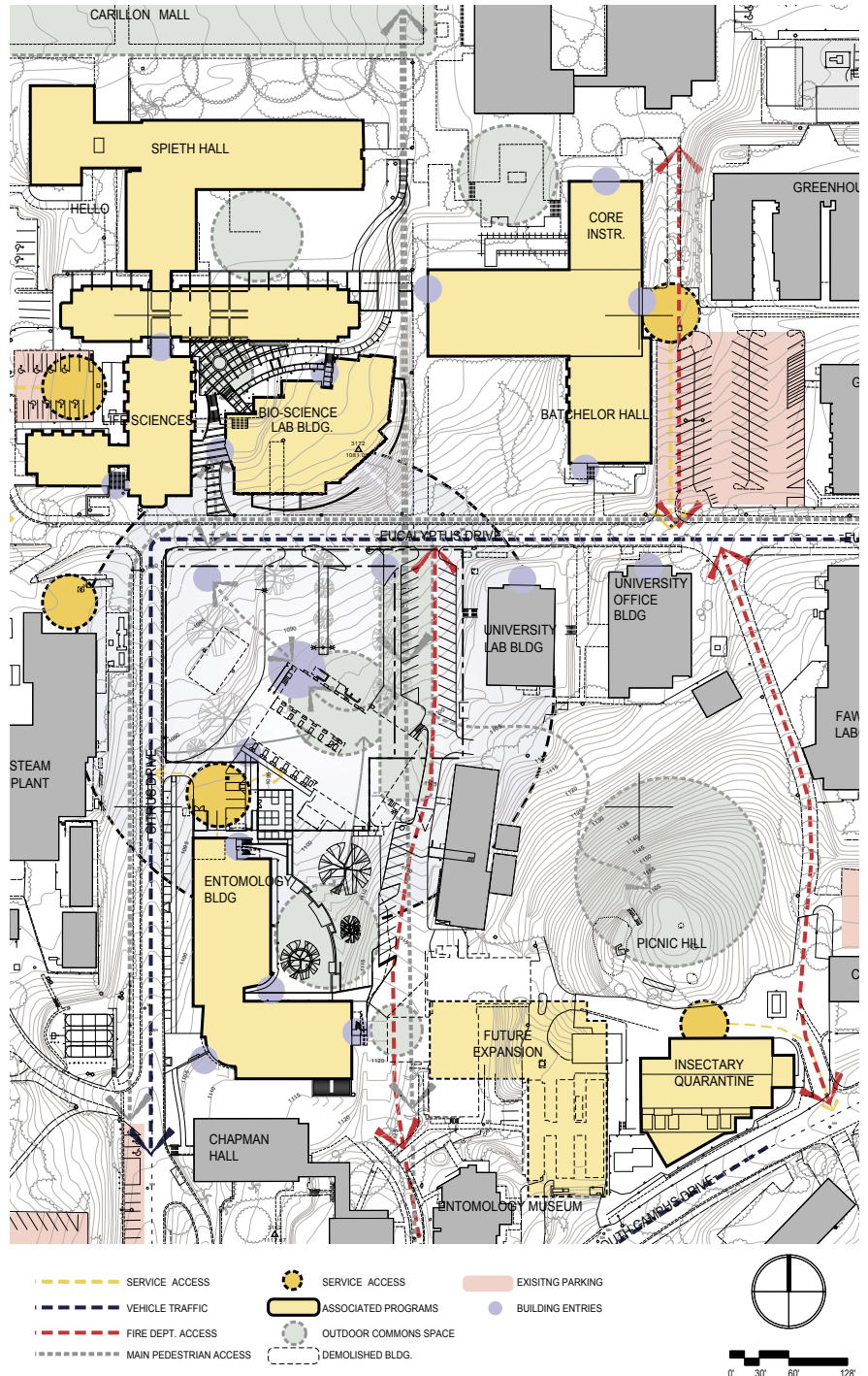

4.11 Site Sections

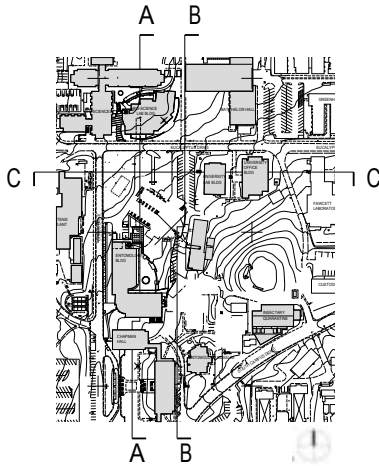

The sections through the site show the existing grades, heights, and mass of the existing, adjacent buildings, and describe the maximum building envelope available for the Genomics Building.

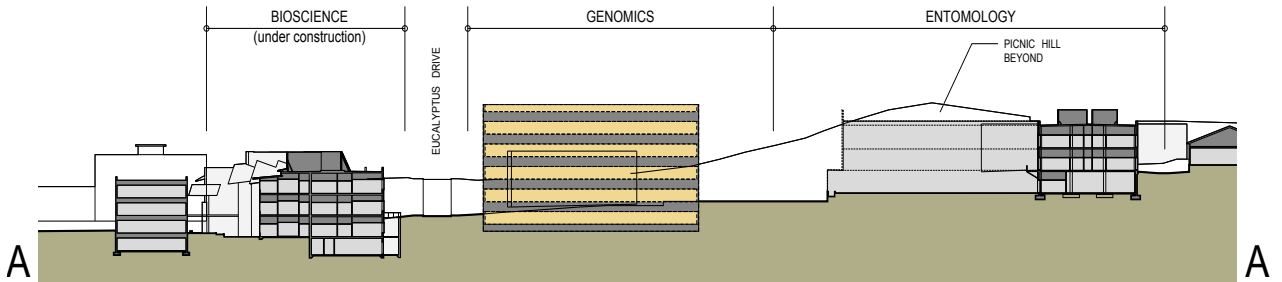

Looking east

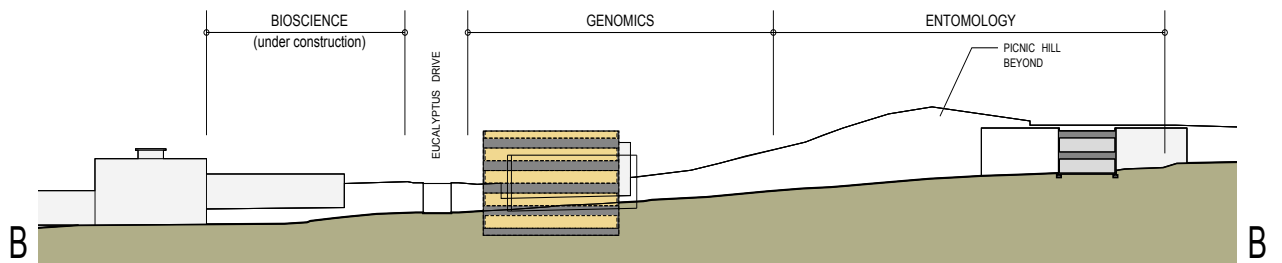

Looking east

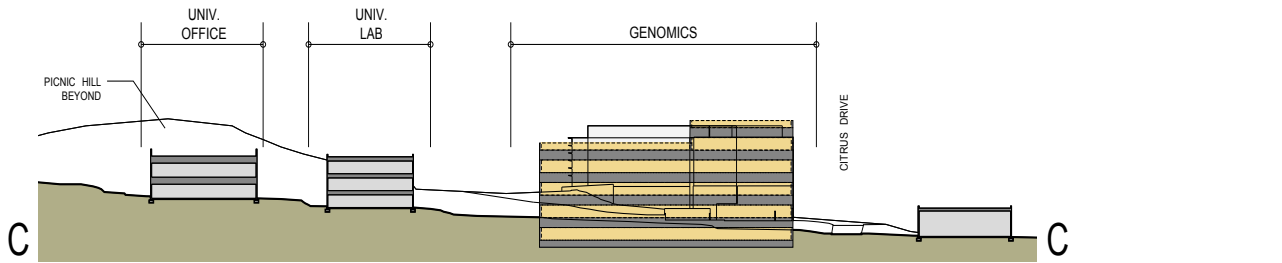

Looking south

5.0 Design Concept

This section of the DPP summarizes the design concepts for the site and the Genomics building.

5.1 Project Ideals

These project ideals speak to the uniqueness of this facility, and will become inherent in the design.

Unique Sense of Place

The Genomics building is a unique facility, and should have a significant presence on campus—its commitment to excellence and achievement should be reflected in the quality and craftsmanship of public and research spaces.

A Distinctive Research Presence

Genomics research projects an aura about science and discovery that is compatible with the physical presence and creative spirit of California. The vitality of the research will be captured in this facility, and will be expressed to those who work and participate in the process.

A Creative, Productive Work Environment

The research environment is functional and stimulating. Intellectual collaboration and interaction are key to scientific discovery. Laboratories are designed for flexibility and adaptability, and the office and support areas are designed for an informal community of research participation.

An Expression of the Value of Research Endeavors

Genomics makes wise use of its financial resources, and values the commitment of people and their time to the realization of the project. The construction of the facility responds to the program and its context, expressing confidence in science and its role in the future.

5.2 Site Concepts

In response to the goals of CNAS and the LRDP, the following concepts have been introduced in the site planning. Refer to the Site Concept drawing below for the illustration of these concepts.

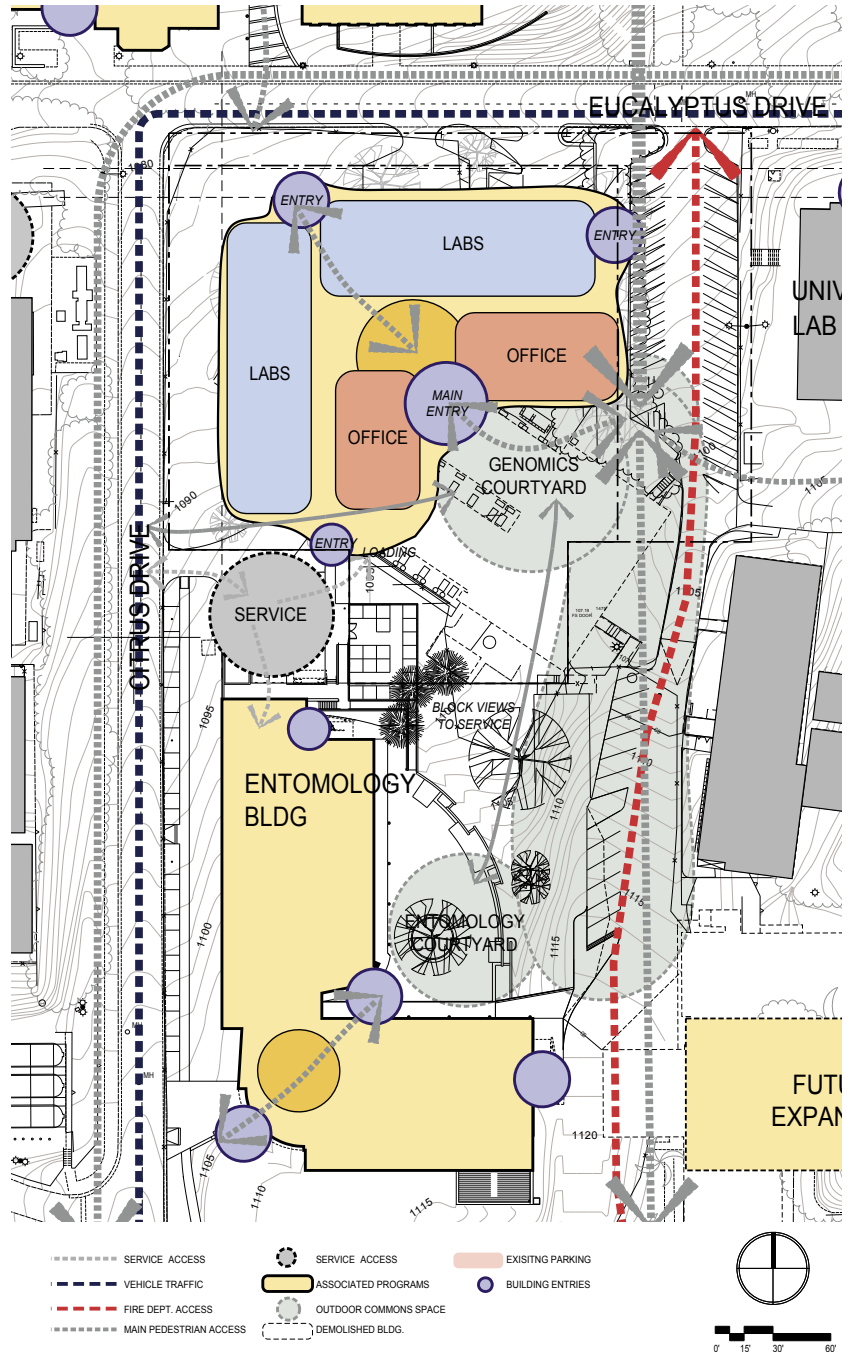

Courtyards and Plazas

Develop the courtyard as a semiprivate space for Genomic's and public use. Enhance and develop the courtyard respecting the scale, orientation and functions that exist within the building. Provide the appropriate enhancement of the extension of the pedestrian mall as it continues to the Entomology I courtyard, and further south to South Campus Drive.

Entries

Provide a campus entrance into Genomics from the northwest and northeast corners of the site. The entrances should be welcoming and create a strong sense of presence. Create a hierarchical sequence of spatial experiences from the public to semi-private within the building perimeter.

Provide the major public entrance at the northeast corner of the site to recognize the primary arrival point from staff and visitor parking.

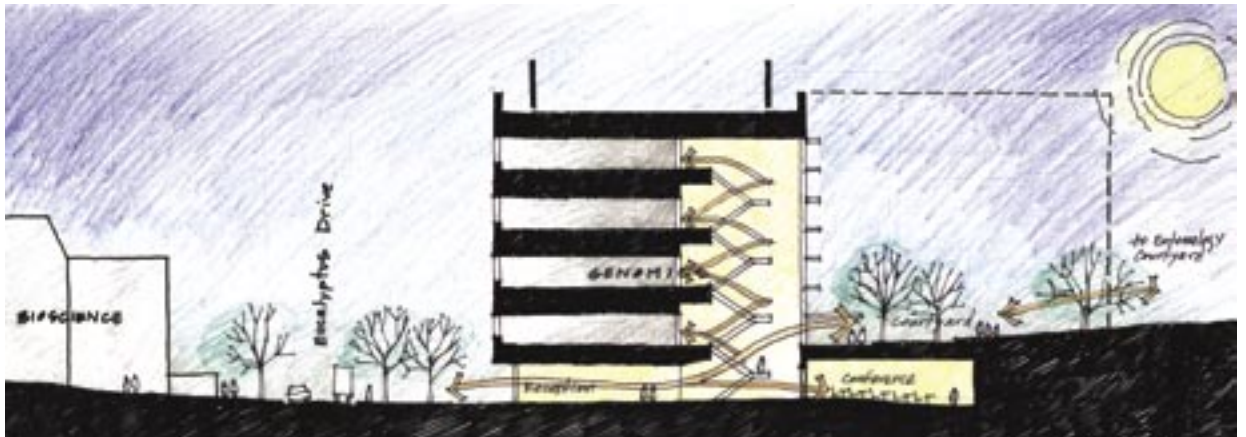

Section looking east

Building Siting

Site the building to respond to sun orientation, prevailing winds, topography and the program. Locate laboratories on the outside perimeter with views to the campus. Locate offices with views into the courtyard and to Picnic Hill. Use the public building functions and circulation as central organizing elements.

Eucalyptus Drive is intended to be a pedestrian and service zone so the scale created by this building is critical. The design proposes a 90' minimum separation to Biological Science, in order to keep the area as open as possible.

Define the edges of the site by generally aligning the new building with the setbacks of the existing buildings along Citrus and Eucalyptus Drives. Respect the massing and proportions of Biological Sciences and Entomology I, and create a density that is appropriate to the site at the edge of the academic core.

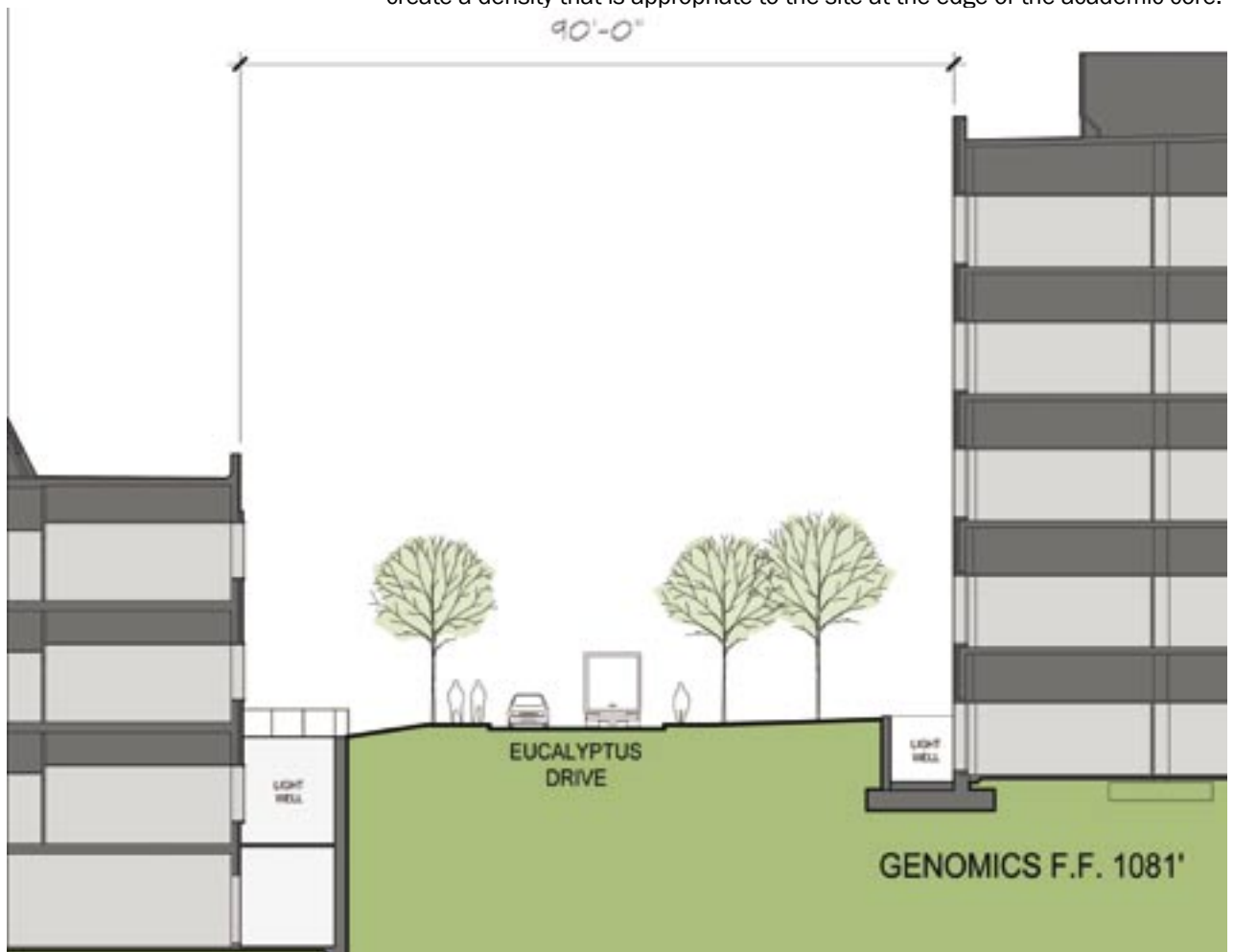

Service

Separate service from the main entries and screen the service area from the courtyard. Maintain emergency vehicle access on the east edge of the site.

5.3 Site and Building Design

The design concept should integrate the building into the overall fabric, character and design of the campus. The new building should reflect the commitment that UCR has to a new generation of campus expansion, with an emphasis on quality design and landscape. The Genomics Building will provide an appropriate building density, while remaining sensitive to the inherent scale and character of the campus.

Landscape

Site

The Campus Design Guidelines listed in the Campus Landscape Guidelines should be incorporated in the new design, considering preservation of existing plant materials, respecting existing attributes of the site, and acknowledging the 20-foot change in grade by providing for drainage, access, views and noise buffers.

Existing planting should be appraised for its ability to survive construction, and new materials should be chosen to match existing materials.

Wayfinding to the building entries at the northeast and northwest corners of the site can be enhanced through the use of distinctive paving patterns and trees that announce the entrance. Tree choices should consider signage and shade tolerance.

The semi-private courtyard should convey intimacy and comfort, providing shade, seating, and opportunities for large or small gatherings. The landscape design could be enjoyed as a microcosm of California agriculture, incorporating plant materials and agricultural forms that demonstrate the research going on within the facility, possibly using distinctive paving to additionally convey research and experimentation.

Trees

The existing Dragon Tree (*Dracaena Draco*) is unusual, and should be boxed and relocated to be a focal point/specimen in a planter area prior to demolition of Entomology Annex. The existing eucalyptus trees along Eucalyptus Drive and other species in the parking and lawn areas will not survive the construction process. Eucalyptus are to be used as the dominant street tree.

New plant materials in the entry court and courtyard should emphasize agriculture, using citrus and other California crops, both as a historical reference, and as an acknowledgment of UCR's commitment to California agriculture.

Entry court trees should be colorful and interesting, drawing attention to the entry. Courtyard trees should be relatively smaller in stature, to accommodate the smaller scale of the courtyard. Screen trees should be evergreen and dense in nature, while the transition trees from the courtyard to the eastern site boundary should be seasonally colorful.

Paving

Paving at the entry courtyard should match the interior courtyard, utilizing the standard, required UCR tan concrete color in a variety of finishes.

Shrubs

Shrubs should be drought-tolerant, easily maintained and colorful, whether planted near buildings or in open spaces. Ultimate shrub heights should respond to window heights and security issues. The UCR campus plant palette, as described in the Campus Landscape Guidelines, should be utilized.

Lighting

Site lighting consisting of pole lights, bollards, step lights and landscape lights will guide visitors through the site at night. Special fixtures at the northwest corner of the site will direct pedestrians to the preferred route north of the building.

Furnishings

Site furnishings are an important feature in the context of this facility, particularly in the courtyard. Some of the issues that must be addressed in the selection of these furnishings include: recalling furnishings used elsewhere on campus comfort ADA accessibility ease of maintenance and durability.

Irrigation

Irrigation should be connected to existing points in the system, and a new automatic controller should be provided as part of the project. Moisture sensors should be included in the irrigation equipment so that an accurate soil profile indicating soil moisture and oxygen can be obtained. Irrigation methods should be studied to determine the most effective method for providing complete ground plane coverage, as well as an enduring deep water application for the trees.

5.4 Building/Site Design Principles

- Entomology and Insectary buildings will be removed in the near future; Boyden will eventually be removed.
- Campus pedestrian mall from the north will terminate at Entomology I; pedestrian connection will continue to AGSM.
- Parking within the zone will be limited to campus service vehicles only.
- Vehicular access will be limited to emergency vehicles and campus services.
- Future building capacity (beyond Genomics) is 125-200,000 gsf, depending on density and approach to open space, and is illustrated below.





View from the north



View from the west



View from the south



View from the east

5.5 Research Floor Organization

The following principles add qualitative dimensions to the program and focus on encouraging intellectual interaction and collegiality:

- Create an environment that facilitates intellectual stimulation and collaboration. Cluster activity spaces to aid in that interaction. Intellectual exchange between researchers, post-doctoral and graduate students occurs in both the offices and in the labs, and the distribution of spaces should encourage these interactions.
- Provide the capability to change and adapt to future space and technological needs. Maintain flexibility within the office zones by creating an office module that can satisfy the need for private offices, open offices and office support functions.
- Create a building which is integrated into the campus fabric and which supports campus planning guidelines and objectives. The institute should have an identity of its own, but should at the same time be fully integrated into the campus through the use of materials, and through building character, scale, massing and configuration.
- Maximize the research space given the resources available.
- Define the building clearly with regard to campus and public accessibility. Provide the appropriate level of internal security at the lab level.

5.6 Research Labs and Offices

Research labs and office layout concepts were studied in a variety of configurations. Providing a range of space for intellectual interaction between researchers is critical, as well as providing flexibility in how the labs and offices are distributed and occupied.

Stacking the research labs and office modules provides economies and flexibility within the building systems. Each floor should provide an average ratio of one faculty office to three research lab modules. The modules meet the need for flexibility, organization, scale and privacy. These diagrams illustrate the opportunities for modular arrangements reviewed by the DPP Committee. The committee prefers office proximity to the labs, while maintaining the modular concept for flexibility and systems efficiencies.

Lab/Office Layout

This page illustrates the possible arrangements of research labs and offices. The DPP Committee reviewed four concept options (Appendix B) and preferred Option C, with the Conference Center on the first floor, because it met their needs for adjacencies, cost constraints, and flexibility.

Option C is organized as an arrangement of modules of research labs and faculty offices around a courtyard. Office spaces are located around the shorter, interior perimeter of the building because of the smaller amount of required assignable area. The lab and lab support modules are located around the street sides of the building because their program areas are larger.

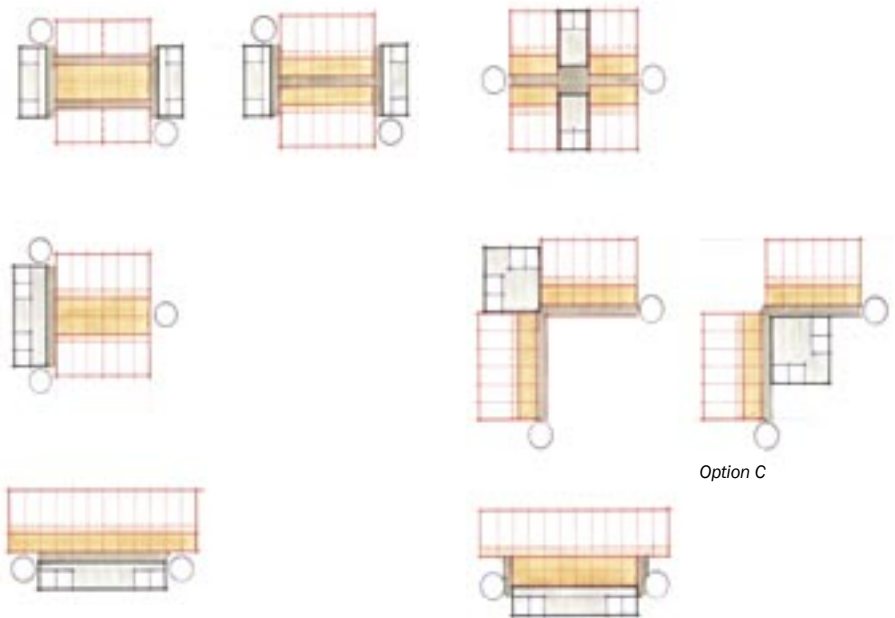

Lab/Office - Prototypes

Option C

5.7 Plan Organization

The L-shaped building is configured to present both a public and a campus side. The orientation responds to the program and the topography of the site. The lower level entry is a secondary campus entry, providing direct access to the Conference Center.

The second level, and at the higher grade, is the primary campus entrance and lobby. On this level, and on the upper floors, are all of the labs, lab support, offices and office support. The diagrams below, shown in more detail in Section 3, illustrate the relationships in each of these categories.

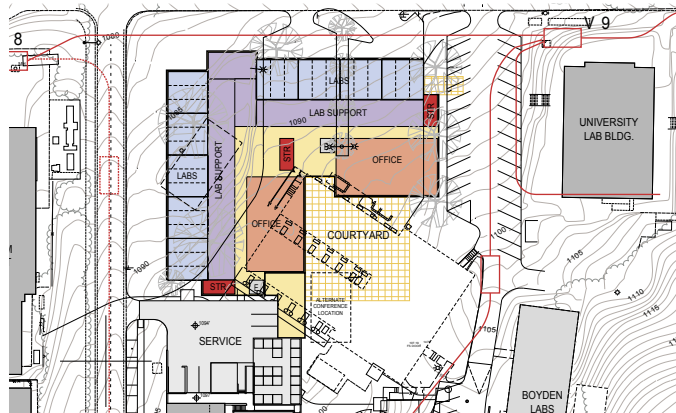

Second Floor Plan (third and fourth are similar)

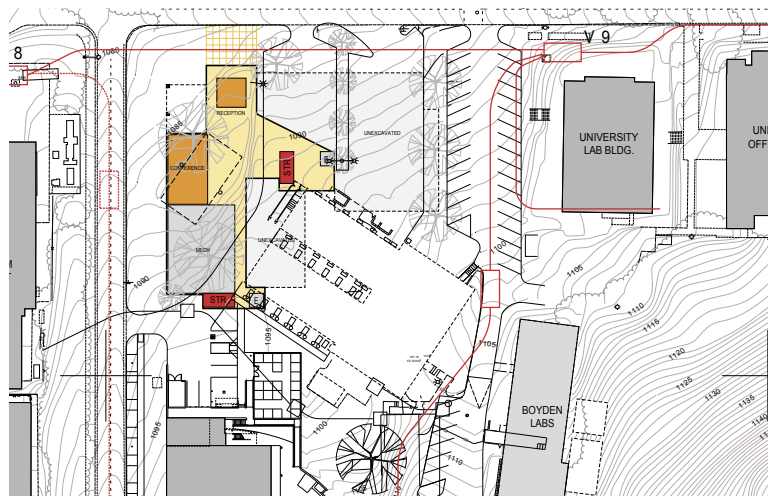

First Floor Plan

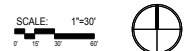

5.8 Concept Building Relationships

These stacked floor plans illustrate the building relationships and distribution of the program spaces.

The second, third, fourth and fifth floors are dedicated to research labs, lab support and offices, and office support.

The first floor is the more public entrance at the corner of Citrus and Eucalyptus Drives, and contains the Conference Room, support, and mechanical space.

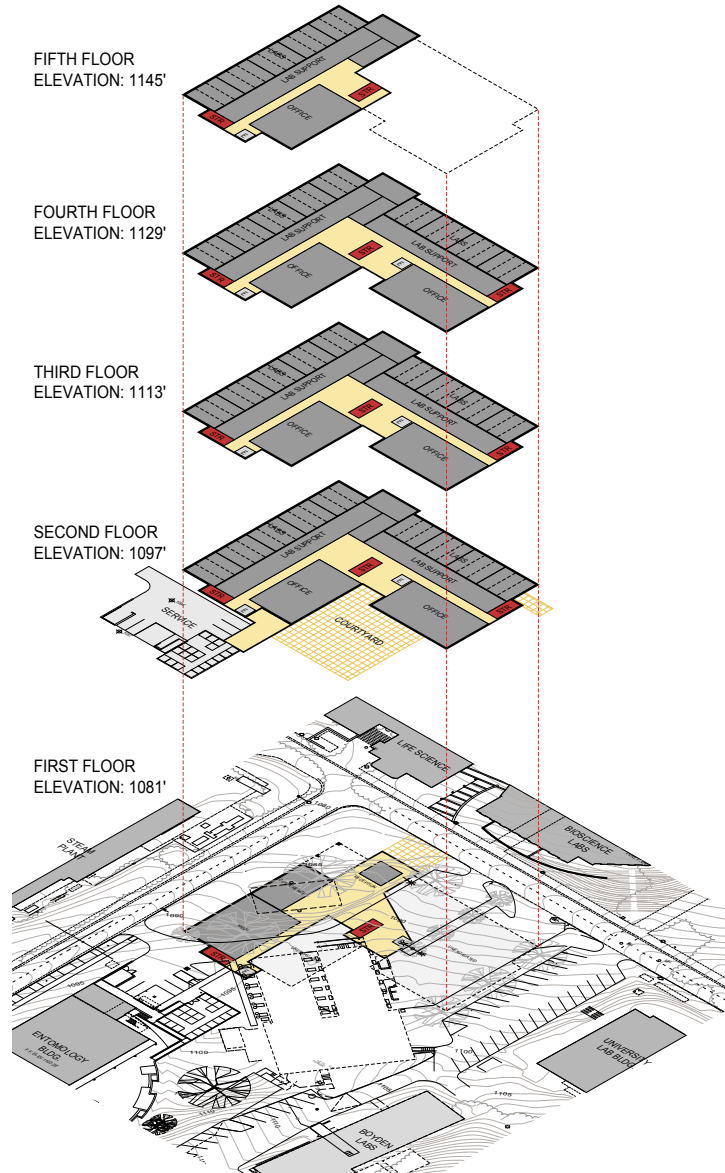

Section Organization

The conceptual, vertical organization of the building consists of a four-story building with the first and second floors at grade level. The second floor is set to allow entry from the pedestrian mall at the northeast corner of the site, and also contains the truck dock and service yard that is shared with Entomology I. All floor-to-floor heights are sixteen feet, which works well with the existing grades, and accommodates the mechanical requirements.

Massing

The site suggests that the massing of the building provides a strong edge along Citrus and Eucalyptus Drives. The labs are configured around these edges and present a formal elevation to the street. The proposed exterior materials are brick and concrete to further express the formality desired. The inside of the courtyard is treated more informally with the arrangement of offices, office bays, and the use of glass. Glass is also used at the building entrances. The air-handling equipment on the roof will be screened and integrated into the building massing.

5.9 Exterior Building Design Goals

The following concepts should be followed during the development of the exterior building design.

1. Provide a well-crafted building that respects and supports the campus context with entrances that are engaging and inviting.
2. Compliment the existing surrounding buildings by a careful integration of similar building materials and similar features such as sunscreens and arcades, without competing with or mimicking the existing context.
3. Develop a sensitive and well-designed expression of a research facility that expresses the vitality of Genomic research and addresses the human factor by emphasizing a people-oriented learning environment.
4. Provide careful attention to the building's proportion and scale, while seeking a timeless design expression.

5. Select exterior cladding materials to include UCR brick, per the campus standard, with window systems and secondary cladding materials such as metal panel, concrete or stone. The materials should be detailed so that the building will age gracefully, at a level of quality that meets or exceeds the campus design standards.
6. Compose the materials so the vision and scale of the elevations reflect the contextual patterns surrounding the project. Care should be taken to coordinate the scale of the exterior composition with the new and existing buildings.
7. Enhance building entries and lobbies by providing inviting design features using quality materials, weather protection, places to meet and sit, quality lighting, signage and graphics, and similar elements.
8. Shield the building's mechanical features from primary view. Integrate screen walls into the massing composition.

5.10 Interior Building Design Goals

The following concepts should be considered during the development of the interior design:

1. Interior corridors should terminate at a window or glazed exit condition for access to natural light and campus views. Fenestration should be sized appropriately for solar orientation and to provide additional passive energy control.
2. Design interactive areas to maximize the opportunity for chance meetings and the interchange of ideas. Include elements such as places to sit, white boards and tack surfaces.
3. Enhance the entry lobby and major circulation with a variety of spatial experiences through quality design, building materials and colors.
4. Use high-quality materials and building systems that integrate into overall building design features. Create a friendly and stimulating work environment.
5. Provide corridors that widen at entries into laboratories, creating a variety of spaces and experiences within corridors.

5.11 Systems Descriptions

The Systems Descriptions (beginning in Appendix E) are the outline of the intended scope for each of the primary building systems under the general categories of Structural Engineering, Mechanical Engineering (including building plumbing), and Electrical Engineering.

6.0 Budget and Cost Plan

6.1 Basis of Cost Plan

This Cost Plan has been prepared for the purpose of developing a project budget. In certain areas, allowances have been established where the process did not allow detailed investigation. It is recommended that on the onset of the next design phase, all cost components be carefully reviewed.

Conditions of Construction

- A start date of December 2005
- A construction period of 26 months
- The general contract will be competitively bid with qualified general and main subcontractors
- There will not be small business set aside requirements
- The contractor will be required to pay prevailing wages
- There are no phasing requirements
- The general contractor will have full access to the site at regular construction hours

6.2 Project Budget

Total Construction Cost	\$37,398,000
Equipment	\$10,200,000*
Indirect Construction Cost	<u>\$5,152,000</u>
TOTAL PROJECT COST	\$53,000,000

**subject to fees to be deducted

6.3 Inclusions

The project consists of a five-story laboratory building of approximately 110,321 gsf with partial 1st and 5th floors. The program includes research laboratories and support spaces, six controlled temperature rooms, faculty and student offices and general administrative functions.

Foundations include reinforced concrete spread footings, elevator pits and subsurface drainage.

The building structure includes reinforced concrete retaining walls and shear walls, reinforced concrete columns, reinforced concrete suspended floor and roof decks, and allowances for mechanical equipment pads and miscellaneous metals and support framing.

Exterior cladding includes steel stud framing, exterior sheathing and insulation, brick veneer with recast concrete trim, interior painted gypsum board lining, aluminum framed insulated windows and curtain wall with low-e finish, aluminum glazed entry doors, hollow metal exit doors and cement plaster soffits. An allowance is also included for miscellaneous architectural trim and sun shading treatment.

Roofing and waterproofing includes waterproofing to elevator pits and retaining walls, rigid insulation under built-up roofing, roof flashings and miscellaneous sheetmetal work, and an allowance for caulking and sealants.

Interior partitions include metal stud framing, batt insulation and painted gypsum board lining, wood doors in hollow metal frames, and interior glazing. Within the laboratory suites it is assumed that 2/3 will be open plan without demising walls.

Interior finishes include carpet, vinyl composition tile and sealed concrete floors to general areas, and ceramic tile at restrooms. Allowances are included for bases and acoustic wall panels, with ceramic wall tile at restrooms. Ceiling finishes include suspended acoustic tile and painted gypsum board, bulkheads and fascias.

Laboratory functional equipment to include general fixed building equipment such as toilet room accessories, signage, window blinds, fire extinguishers and cabinets, projection screens, markerboards and tackboards. Allowances are included for storage shelving and millwork, and non-laboratory cabinets and countertops. Also included is laboratory cabinets and countertops (67% included in construction cost, 33% included in Group II/III budgets), laboratory equipment including fume hoods, autoclaves, controlled temperature rooms and general laboratory accessories. (See cost plan for exclusions and special conditions)

Vertical transportation includes interior stair flights and (2) traction elevators. Roof access is provided by one elevator and one stair.

Plumbing includes sanitary and institutional fixtures (installation and local connection only), floor drains, hose bibbs, water heating equipment, laboratory equipment and distribution pipework, including air, vacuum, deionized water, industrial hot and cold water, special gases, acid waste and neutralization, gas and roof drainage.

Heating, ventilating and air conditioning includes campus fed chilled and steam systems, thermal expansion compensation and circulation equipment, pipework distribution including hot and chilled water, steam/condensate return, equipment cooling, air handling units, including exhaust ventilation, fan-coil units, humidification, terminal boxes and sound attenuation. Air distribution and return, including laboratory exhaust ventilation, building management and laboratory pressurization controls, (7) HEPA filters at radio-isotope hoods and general/laboratory ventilation.

Electrical includes normal power generation and distribution, emergency power generation and distribution, machine and equipment and user convenience power, lighting, telephone/data, audio/visual conduit and cable, MATV, fire alarms and security card-key access.

Fire protection includes a complete automatic wet sprinkler system to the general building and a dry-preaction sprinkler system at the cluster farm.

Site preparation includes an allowance for general site clearing and rough grading.

Site development includes allowances for hard and soft landscaping.

Site utilities include allowances for chilled water and steam, domestic and fire water, gas, sewer, power and telecommunications/signals.

Bidding Process - Market Conditions

This document is based on the measurement and pricing of quantities wherever information is provided and/or reasonable assumptions for other work not covered in the drawings or specifications, as stated within this document. Unit rates have been obtained from historical records and/or discussion with contractors. The unit rates reflect current bid costs in the area. All unit rates relevant to subcontractor work include the subcontractors overhead and profit unless otherwise stated. The mark-ups cover the costs of field overhead, home office overhead and profit and range from 15% to 25% of the cost for a particular item of work.

Pricing reflects probable construction costs obtainable in the project locality on the date of this statement of probable costs. This estimate is a determination of fair market value for the construction of this project. It is not a prediction of low bid. Pricing assumes competitive bidding for every portion of the construction work for all subcontractors and general contractors, with a minimum of 4

bidders for all items of subcontracted work and 6-7 general contractor bids. Experience indicates that a fewer number of bidders may result in higher bids, conversely an increased number of bidders may result in more competitive bids.

Since Davis Langdon Adamson has no control over the cost of labor, material, equipment, or over the contractor's method of determining prices, or over the competitive bidding or market conditions at the time of bid, the statement of probable construction cost is based on industry practice, professional experience and qualifications, and represents Davis Langdon Adamson's best judgment as professional construction consultant familiar with the construction industry. However, Davis Langdon Adamson cannot and does not guarantee that the proposals, bids, or the construction cost will not vary from opinions of probable cost prepared by them.

6.4 Exclusions

- Design, testing, inspection or construction management fees
- Architectural and design fees
- Scope change and post contract contingencies
- Assessments, taxes, finance, legal and development charges
- Environmental impact mitigation
- Builder's risk, project wrap-up and other owner-provided insurance programs
- Land and easement acquisition
- Cost escalation beyond a construction midpoint of January 2007
- Owner supplied and installed furniture, fixtures and equipment
- Loose furniture and equipment, except as specifically identified
- Growth chambers
- Biological safety cabinets, glassware washers and dryers
- Hazardous material handling, disposal and abatement
- Compression of schedule, premium or shift work, and restrictions on the contractor's working hours
- Demolition and removal of existing building structures
- Work to streets and sidewalks
- CCTV surveillance cameras and monitoring
- Audio visual equipment
- Atrium smoke evacuation
- Hazardous material handling, disposal and abatement
- Compression of schedule, premium or shift work, and restrictions on the contractor's working hours
- Uninterrupted power source (UPS) - by User.
- Master antenna TV equipment and cabling

- Sump pump and sewage ejector
- Public address
- Utility tunnel extensions and connections
- Underground diesel generator fuel oil storage
- FM-200 fire suppression systems
- Telephone/data “active” equipment, including hubs, routers, LAN, switches, servers, etc.
- BSL-3 Suite
- Owner-sponsored mechanical and electrical commissioning
- Additional Functional furnishings and equipment will be procured through the Group II/III Budget
- Proximity sensors on fume hoods
- Fit-out of Cluster Farm
- LEED Commissioning

	Gross Floor Area	\$ / SF	\$x1,000
Building	110,321 SF	289.24	31,909
Sitework	75,000 SF	21.75	1,632
<i>TOTAL Building & Sitework, CCCI 4019 (April 2003)</i>			<i>33,541</i>
* Allowance for Rising Costs @ 3.0% PA	11.50%		3,857
<i>TOTAL Building & Sitework with Alternates, January 2007</i>			<i>37,398</i>

* Davis Langdon Adamson is recommending an annual rate of 4.0% based on current market conditions.

Please refer to the Inclusions and Exclusions sections of this report

6.5 Overall Summary

		Gross Area: 110,321 SF	
		\$/SF	\$x1,000
1.	Foundations	3.21	354
2.	Vertical Structure	11.26	1,242
3.	Floor & Roof Structures	22.40	2,471
4.	Exterior Cladding	29.15	3,216
5.	Roofing & Waterproofing	3.06	337
<i>Shell (1-5)</i>		69.07	7,620
6.	Interior Partitions, Doors & Glazing	14.00	1,544
7.	Floor, Wall & Ceiling Finishes	9.95	1,098
<i>Interiors (6-7)</i>		23.95	2,643
8.	Function Equipment & Specialties	28.01	3,090
9.	Stairs & Vertical Transportation	6.50	718
<i>Equipment & Vertical Transportation (8-9)</i>		34.51	3,807
10.	Plumbing Systems	19.60	2,162
11.	Heating, Ventilating & Air Conditioning	51.25	5,654
12.	Electric Lighting, Power & Communications	32.72	3,610
13.	Fire Protection Systems	3.00	331
<i>Mechanical & Electrical (10-13)</i>		106.57	11,756
Total Building Construction (1-13)		234.10	25,826
14.	Site Preparation & Demolition	0.00	0
15.	Site Paving, Structures & Landscaping	0.00	0
16.	Utilities on Site	0.00	0
Total Site Construction (14-16)		0.00	0
TOTAL BUILDING & SITE (1-16)		234.10	25,826
	General Conditions	8.00%	18.73
	Contractor's Overhead & Profit or Fee	4.00%	10.12
PLANNED CONSTRUCTION COST		<i>April 2003</i>	262.95
	Contingency for Design Development	10.00%	26.30
RECOMMENDED BUDGET		<i>CCCI 4019</i>	31,909

6.6 Building Component Summary

6.7 Sitework Component Summary

	Gross Area: 75,000 SF		
	\$/SF	\$x1,000	
1. Foundations	0.00	0	
2. Vertical Structure	0.00	0	
3. Floor & Roof Structures	0.00	0	
4. Exterior Cladding	0.00	0	
5. Roofing & Waterproofing	0.00	0	
<i>Shell (1-5)</i>	0.00	0	
6. Interior Partitions, Doors & Glazing	0.00	0	
7. Floor, Wall & Ceiling Finishes	0.00	0	
<i>Interiors (6-7)</i>	0.00	0	
8. Function Equipment & Specialties	0.00	0	
9. Stairs & Vertical Transportation	0.00	0	
<i>Equipment & Vertical Transportation (8-9)</i>	0.00	0	
10. Plumbing Systems	0.00	0	
11. Heating, Ventilating & Air Conditioning	0.00	0	
12. Electric Lighting, Power & Communications	0.00	0	
13. Fire Protection Systems	0.00	0	
<i>Mechanical & Electrical (10-13)</i>	0.00	0	
<i>Total Building Construction (1-13)</i>	0.00	0	
14. Site Preparation & Demolition	1.73	129	
15. Site Paving, Structures & Landscaping	9.52	714	
16. Utilities on Site	6.36	477	
<i>Total Site Construction (14-16)</i>	17.61	1,321	
<i>TOTAL BUILDING & SITE (1-16)</i>	17.61	1,321	
General Conditions	8.00%	1.41	106
Contractor's Overhead & Profit or Fee	4.00%	0.76	57
<i>PLANNED CONSTRUCTION COST</i>	<i>April 2003</i>	19.78	1,484
Contingency for Design Development	10.00%	1.97	148
<i>RECOMMENDED BUDGET</i>	<i>CCCI 4019</i>	21.75	1,632

7.0 Schedule

7.1 Overview

Included in this section is a conceptual project schedule that outlines the four phases of the project, including the Detailed Project Program (DPP), Project Planning Guide (PPG), Design and Construction.

Key issues to be addressed on the project that may affect the schedule include:

- Completion of a new geotechnical report and site survey
- Comprehensive review of building code issues
- Clarification of project delivery method using fast-track or other process

7.2 Detailed Project Program

The purpose of the DPP phase is to prepare a program, concept, cost model and schedule to aid in preparation of the Project Planning Guide. The DPP phase began in late January 2003 with SRG Partnership, Inc. as the programming and planning consultant working with the University of California, Riverside. The original DPP was completed in spring 2003. The final DPP was revised to expand the program, and was completed in January 2004.

7.3 Project Planning Guide (PPG)

The purpose of the PPG is to provide specific project justification based on information provided in the DPP. The PPG phase was completed in fall 2003.

7.4 Design Phases

Following completion of the PPG and approval of funding for design, the University will proceed with selection of an architect and design team. The design process is anticipated to begin in July 2004, and is anticipated to take approximately 14 to 16 months.

7.5 Construction

This schedule is based on the demolition of the Entomology Annex prior to the start of Genomics construction. Construction is anticipated to be approximately 26 months, with completion in spring 2008.

7.6 Graphic Schedule

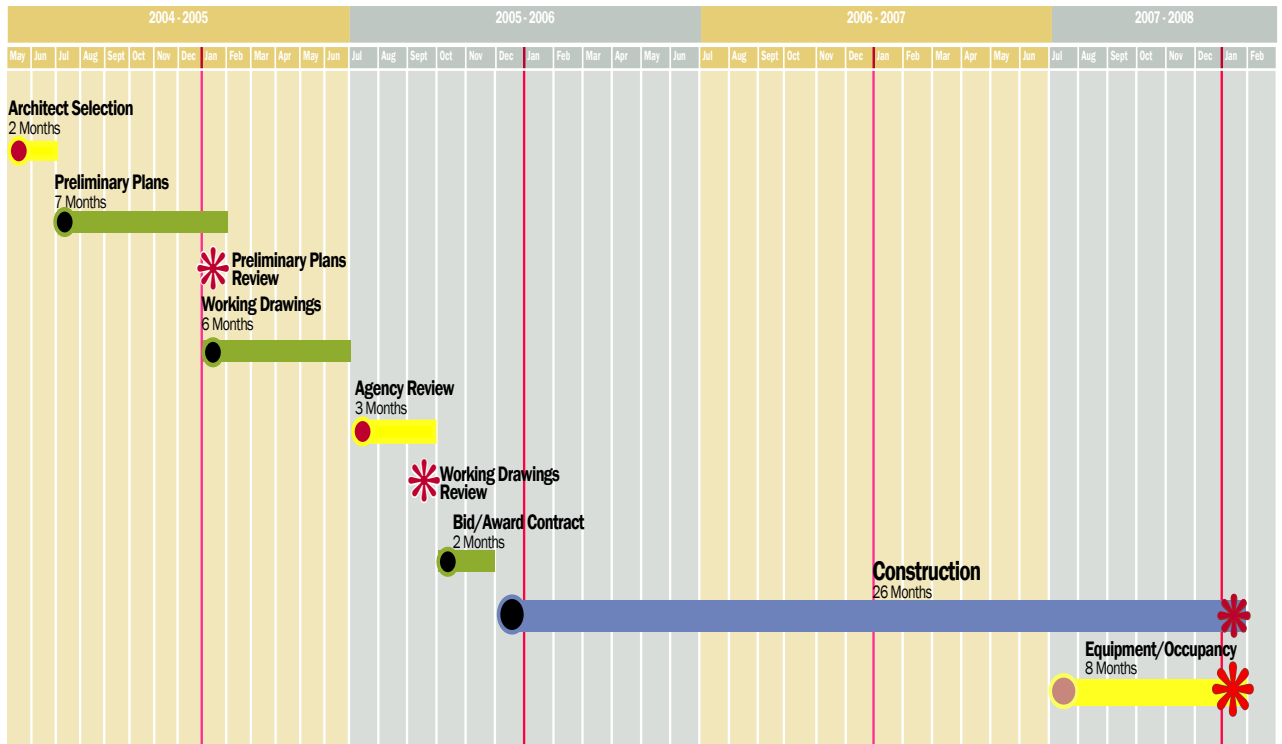

Appendix A

Site Selection Criteria

Campus

Planning/LRDP

Compliance of site development to campus and district planning issues, including principles established in the proposed LRDP (2003 draft), such as access, circulation, building massing and character, infrastructure, and functional use.

Infrastructure

Availability of campus service and utilities to the site, including domestic water, chilled water, sewer, steam, power, telecom and similar requirements.

Parking/Circulation

Proximity of parking for building users, assuming that limited parking will be provided on-site and all other occupants will park off-site; access/circulation response.

Project

Buildable Zone

Ability of site to accommodate initial building area (110,320 gsf) and potential future expansion (to be quantified); constraints on building configuration and flexibility.

Program Relationships

Proximity between key programs related to Genomics research, including biological sciences, entomology/pest management and core instrumentation.

Site Qualities

Qualitative characteristics of the site, including program image/visibility, views, natural light, vegetation, topography, and adjacent facilities







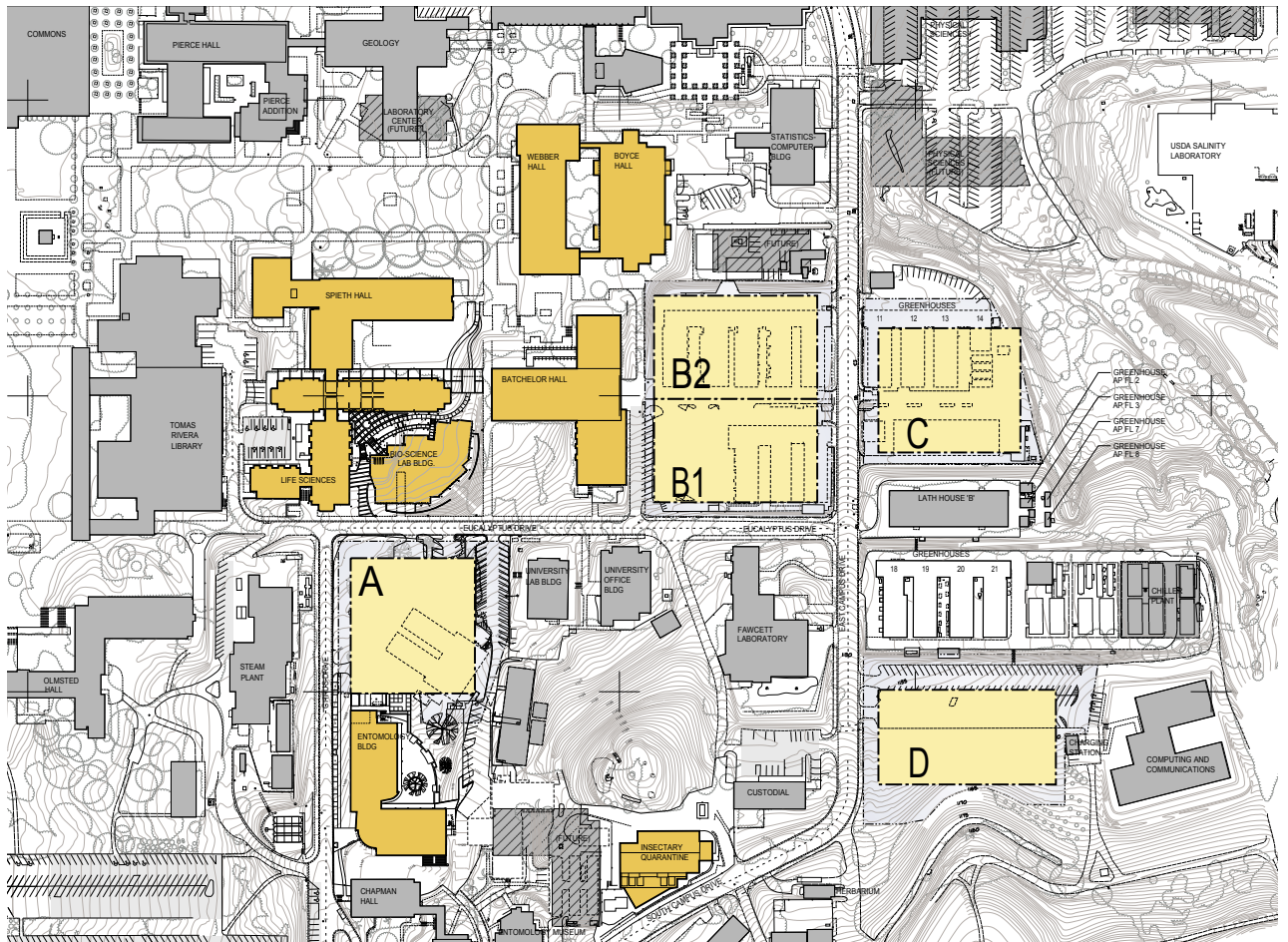

















Constructibility

Site constraints on construction, including access, staging, soils, and similar issues; impact of construction on adjacent operations, including access, noise, and vibration.

Site Options



Site Criteria

	 A Pest Management		B₁ Batchelor South		B₂ Batchelor North	
CAMPUS	Rating	Comments	Rating	Comments	Rating	Comments
Planning/LRDP		+ Complies with draft 2003 LRDP + Site within science/CNAS zone + Close to campus core + Initiates campus enhancements (Picnic Hill, pedestrian mall)		+ Complies with draft 2003 LRDP + Site within science/CNAS zone + Close to core + Potentially underbuilds site		+ Complies with draft 2003 LRDP + Site within science/CNAS zone + Close to core + Potentially underbuilds site
Infrastructure		+ Good availability of campus utilities + Immediate access to utility tunnel system		+ Good availability of campus utilities + Immediate access to utility tunnel system		+ Good availability of campus utilities + Immediate access to utility tunnel system
Parking/Circulation		+ Existing shared service area at Entomology + Parking nearby at lot 9, 6 + Good emergency vehicle access - Access from limited access street (campus vehicles only)		+ Good vehicular access from public street + Good emergency vehicle access + Parking close at lots 6, 13, 9 - Constrained service access and area		+ Good vehicular access from public street + Good emergency vehicle access + Parking close at lots 6, 13, 9 - Constrained service access; access on ground floor
PROJECT						
Buildable Zone		+ Good area for building size; 77,000 sf + Flexible site configuration + Appropriate site for building mass - Expansion possible on adjacent site		- Fair area for building size; 63,000 sf - Shadows greenhouse to north - Displaces greenhouses/Nematode IF + Expansion on adjoining site		- Fair area for building size; 63,000 sf - Expansion only on adjoining site - Displaces greenhouses/speciality labs
Program Relationships		+ Close proximity to Core Instrumentation, Biological Sciences + Prominent corner site on active intersection		+ Good proximity to related programs + Prominent corner site on active intersection		+ Good proximity to related programs + Prominent site on main street
Site Qualities		+ Integral to campus core; internalized presence + Good natural light; internal/campus views, contextual image + Pedestrian mall + Picnic Hill adjacent - Topographical challenges		+ Good natural light + Good external visibility/image + Opportunity for signature image + Great views to campus, valley, mountains - Poor Courtyard quality - Poor existing context to north		+ Good natural light + Fair external visibility/image + Opportunity for signature image - Poor existing context to west/south
Constructibility		- Noise impact on adjacent buildings - Topography - Staging/construction conflict w/concurrent bioscience construction		- Greenhouse Replacement cost - Constrained site/limited staging area - Topography - Conflict with Batchelor service		- Greenhouse Replacement cost - Constrained site/limited staging area - Conflict with Batchelor service
SUMMARY		+ Program relationships, service, parking proximity - Construction staging		+ Visibility/presence, views; program relationships - Constrained area for building size, shading to north, constructibility, building organization, greenhouse replacement cost; underbuilds site - Existing context		+ Visibility/presence; program relationships + greenhouse replacement cost - Underbuilds site - Existing context



C

East of Batchelor

D

Parking Lot #9

CAMPUS

	Rating	Comments	Rating	Comments
Planning/LRDP		+ Complies with draft 2003 LRDP + Site within science/CNAS zone - Periphery of campus; further from core		+ Site within science/CNAS zone - Requires amendment to draft 2003 LRDP - Periphery of campus; more remote from core - Move grove
Infrastructure		+ Good availability of campus utilities - Remote utility tunnel - Steam extension required		- Longer steam extension required; remote utility tunnel - Low water pressure - Steam extension required
Parking/Circulation		+ Good vehicular access from public street + Good emergency vehicle access + Parking close at lots 6, 13, 9 - Constrained service access and area; access on ground floor		+ Good vehicular access from public street + Good emergency vehicle access - Constrained service access and area; conflicts w/C&C - Parking remote at lots 6, 13

PROJECT

Buildable Zone		+ Good area for building size; 75,000 sf - Expansion on adjoining site - Displaces greenhouses & speciality labs		+ Good area for building size; 94,000 sf - Expansion on adjoining site would displace lath house - Expansion difficult
Program Relationships		+ Prominent site on main street - Modest proximity to related programs - Requires pedestrian street crossing		+ Prominent site on main street - Remote proximity to related programs; uphill - Requires pedestrian street crossing
Site Qualities		+ Good natural light + Fair external visibility/image + Opportunity for signature image + Good views to campus, valley, mountains		+ Good natural light + Good external visibility/image + Opportunity for signature image + Good views to campus, valley, mountains - Steep topography
Constructibility		+ No service conflict - Site/limited staging area - Greenhouse Replacement cost		+ No greenhouse replacement cost - Constrained site/modest staging area - Access to C&C, chiller; C&C parking conflict - Impact on grove

SUMMARY

	+ Visibility/presence, views; program relationships - Constrained area for building size, constructibility, building organization - Greenhouse replacement cost - Requires pedestrian street crossing - Existing context		+ Visibility/presence, views, no replacement cost - Modest area for building size, program relationships, constructibility, building organization, service; topography - Requires pedestrian street crossing
--	--	--	--

Appendix B

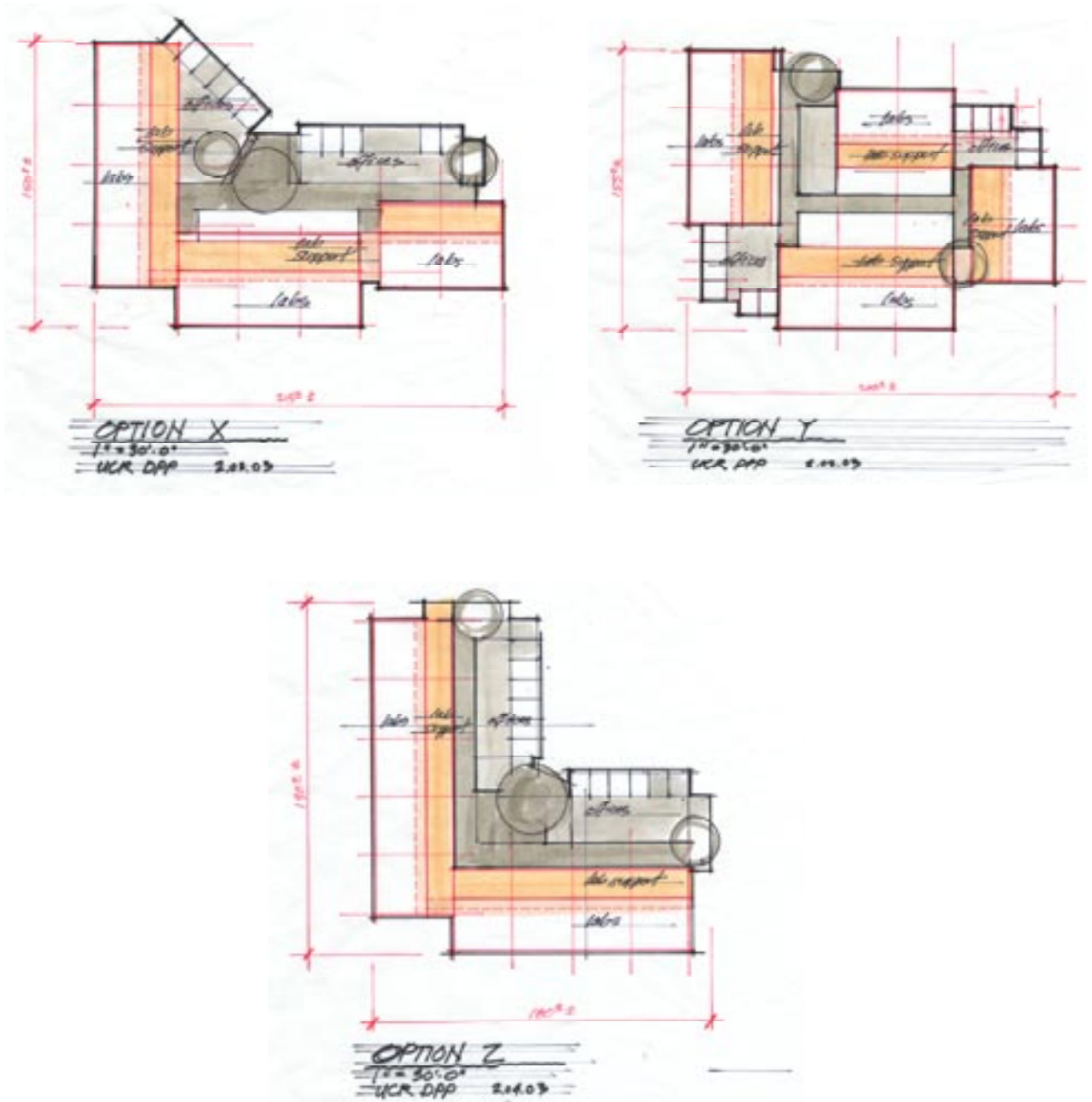

Early building concepts explore alternate lab/office relationships.

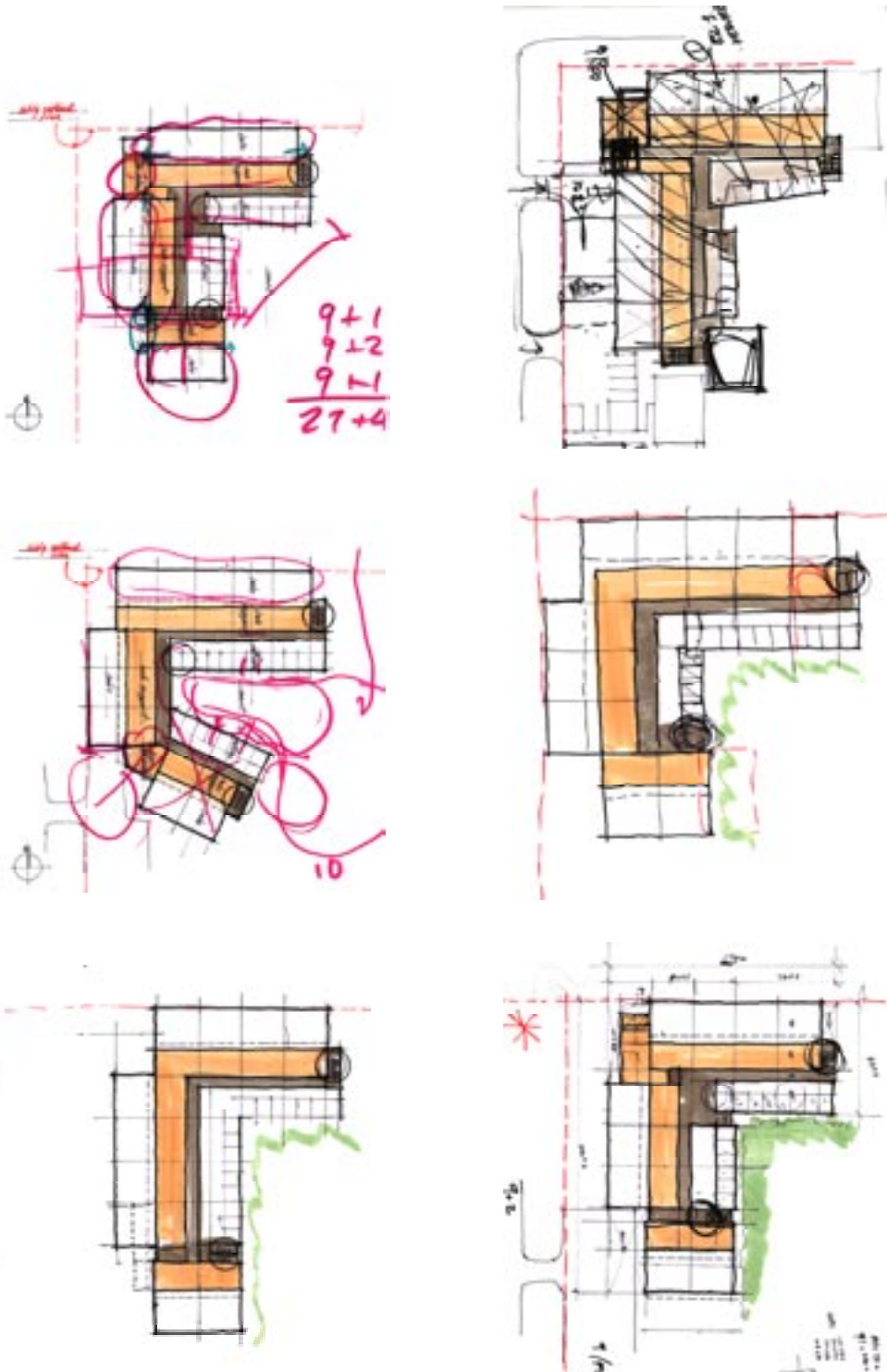

Early building concepts adjust program to site conditions.



Early building concepts explore courtyard based options.

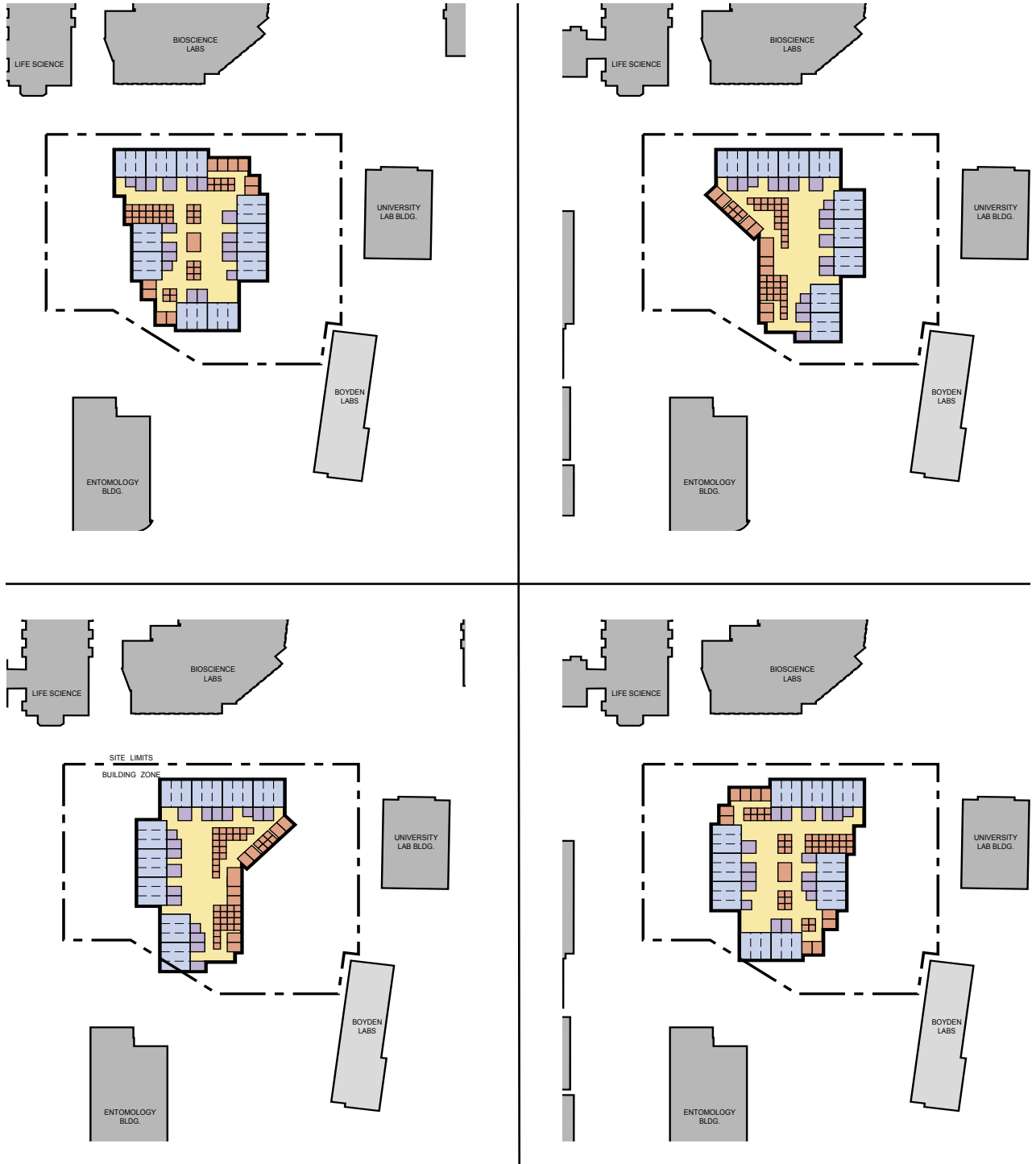

Early building concepts explore cluster-based options.

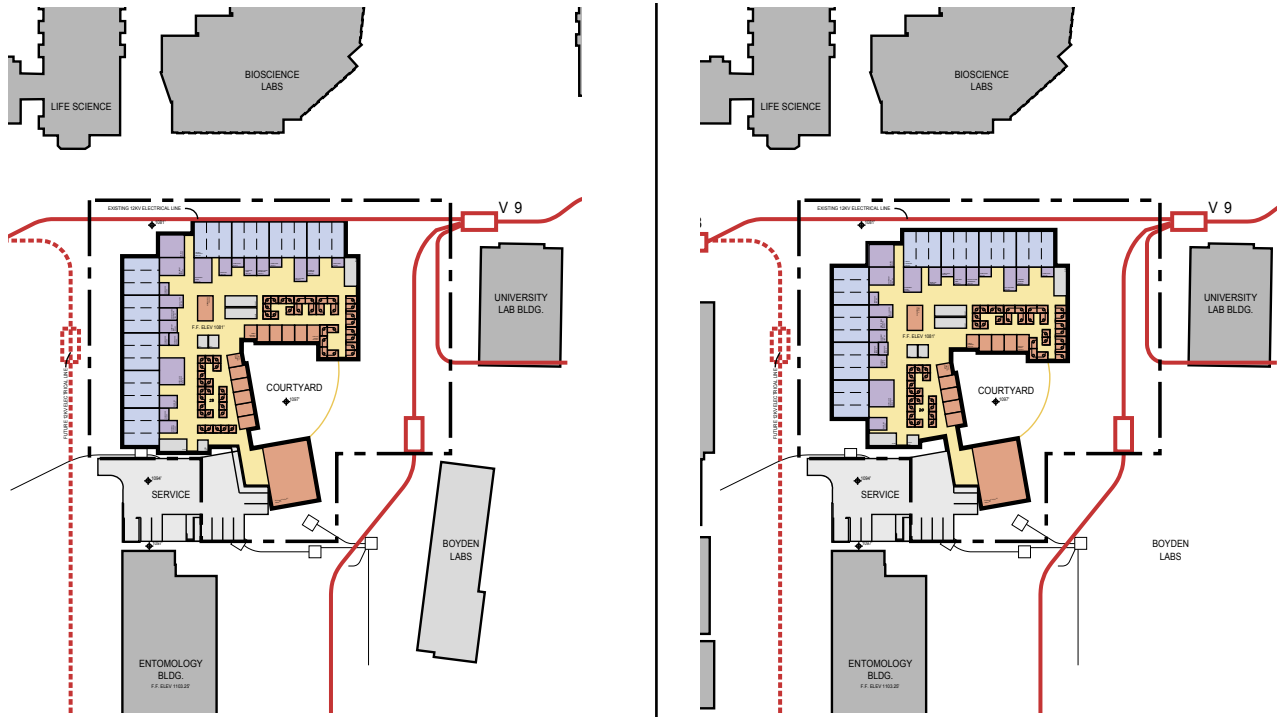

More refined building options test number of labs per floor.

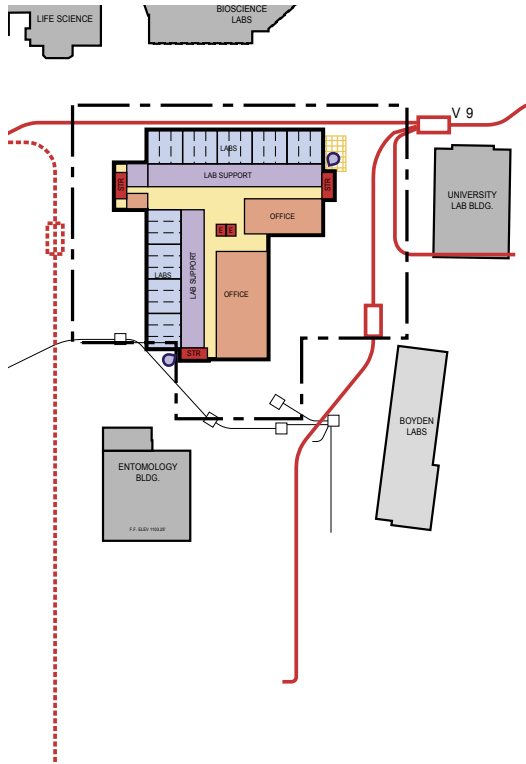

Second Floor

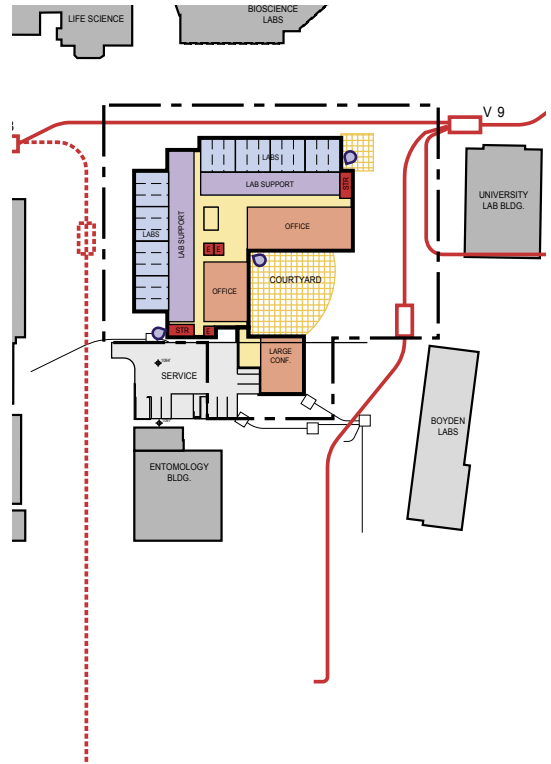

Second Floor

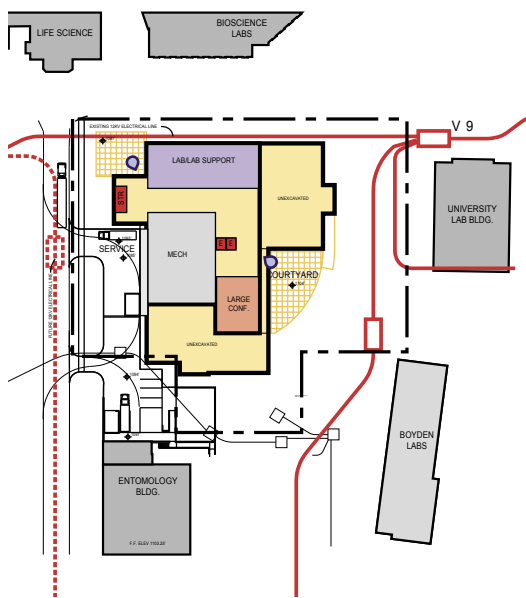

First Floor

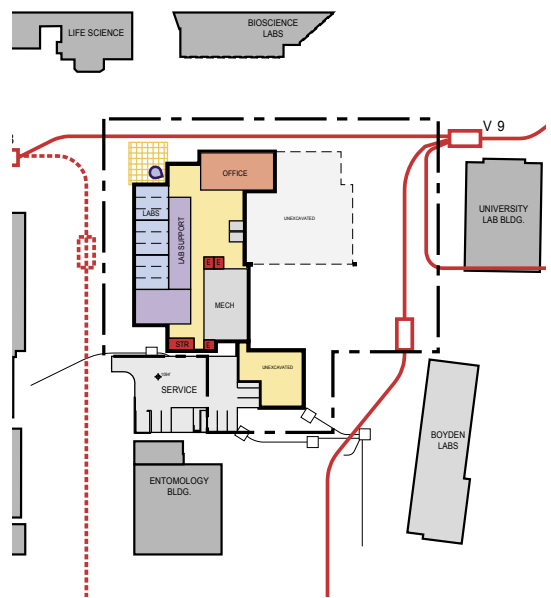

First Floor

Refinement of building concept explores the effects of various site conditions and restrictions including proximity to existing buildings and service.



Second Floor

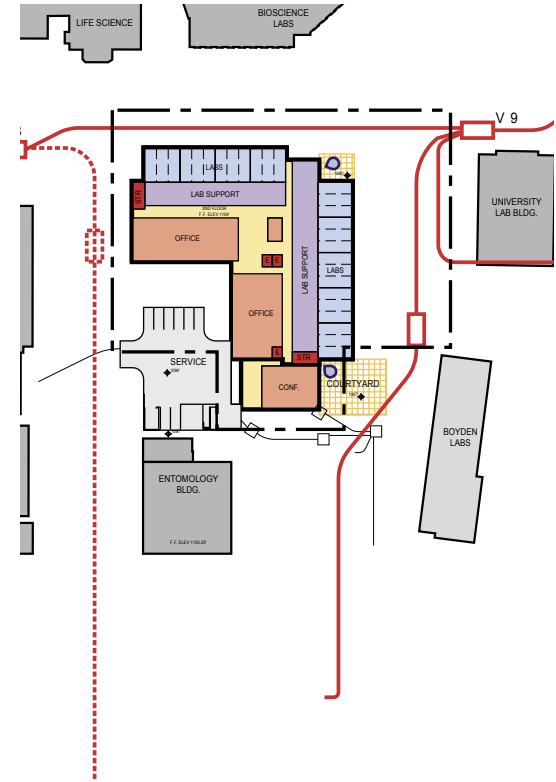

Second Floor

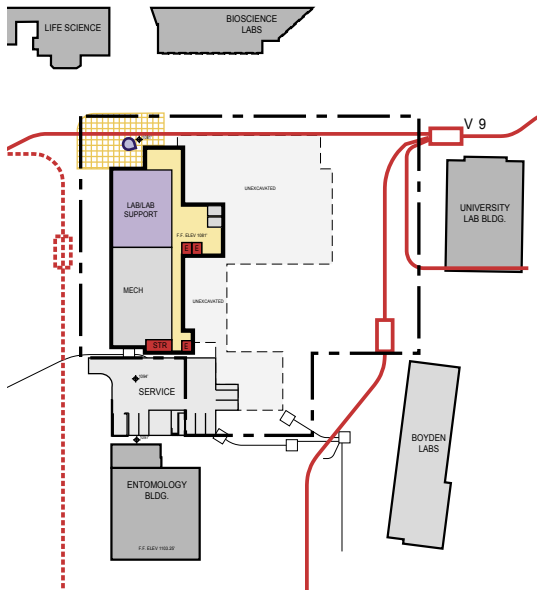

First Floor

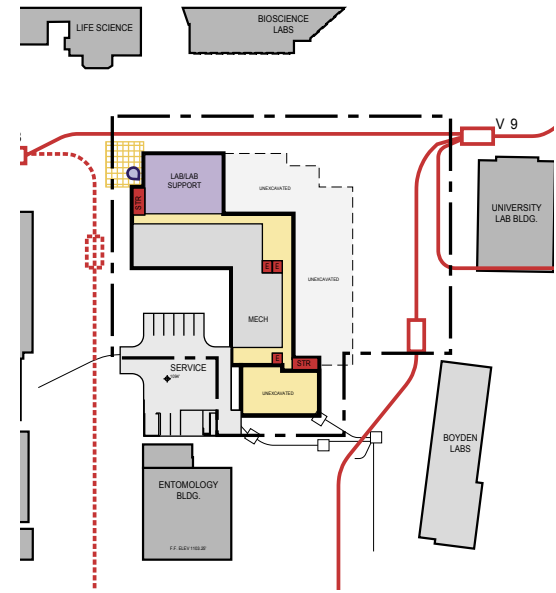

First Floor

Refinement of building concept explores the effects of various site conditions and restrictions including proximity to existing buildings and service.



Early exploration of site concepts for the demonstration site plan.

Appendix C

DAVIS LANGDON ADAMSON



**DETAILED PROJECT PROGRAM
COST PLAN**

for

**Genomics Building
University of California, Riverside
Riverside, California**

February 9, 2004

DETAILED PROJECT PROGRAM COST PLAN

for

**Genomics Building
University of California, Riverside
Riverside, California**

SRG Partnership
621 SW Morrison Street
Suite 200
Portland, Oregon 97205

Tel: (503) 222-1917
Fax: (503) 294-0272

February 9, 2004

CONTENTS

	Page Nos.
Basis of Cost Plan	1
Inclusions	2-4
Exclusions	5-6
Overall Summary	7
Building Areas & Control Quantities	8
Building Component Summary	9
Building Component Budgets	10-18
Sitework Component Summary	19
Sitework Component Budgets	20-21
Cluster Farm Budget	22

BASIS OF COST PLAN

<u>Cost Plan Prepared From</u>	Dated	Received
Drawings issued for		
Architectural		
Site Plan with building footprint	Undated	02/13/03
Space Program Summary	Undated	01/14/04
Laboratory Room Diagrams and Room Data Sheets	Undated	02/14/03
Laboratory Design Criteria	Undated	02/14/03
Project Schedule	01/07/04	01/14/04
Discussions with the Project Architect and Engineers		

Conditions of Construction

The pricing is based on the following general conditions of construction

A start date of December 2005

A construction period of 26 months

The general contract will be competitively bid with qualified general and main subcontractors

There will not be small business set aside requirements

The contractor will be required to pay prevailing wages

There are no phasing requirements

The general contractor will have full access to the site at regular construction hours

INCLUSIONS

The project consists of a five story laboratory building of approximately 110,321 gross square feet. The program includes research laboratories and support spaces, controlled temperature rooms (8), faculty and student offices, and general administrative support functions.

Foundations include reinforced concrete spread footings, elevator pits and subsurface drainage.

The building structure includes reinforced concrete retaining walls and shear walls, reinforced concrete columns, reinforced concrete suspended floor and roof decks, and allowances for mechanical equipment pads and miscellaneous metals and support framing.

Exterior cladding includes steel stud framing, exterior sheathing and insulation, brick veneer with recast concrete trim, interior painted gypsum board lining, aluminum framed insulated windows and curtain wall with low-e finish, aluminum glazed entry doors, hollow metal exit doors and cement plaster soffits. An allowance is also included for miscellaneous architectural trim and sun shading treatment.

Roofing and waterproofing includes waterproofing to elevator pits and retaining walls, rigid insulation under built-up roofing, roof flashings and miscellaneous sheetmetal work, and an allowance for caulking and sealants.

Interior partitions include metal stud framing, batt insulation and painted gypsum board lining, wood doors in hollow metal frames, and interior glazing. Within the laboratory suites it is assumed that 2/3 will be open plan without demising walls.

Interior finishes include carpet, vinyl composition tile and sealed concrete floors to general areas, and ceramic tile at restrooms. Allowances are included for bases and acoustic wall panels, with ceramic wall tile at restrooms. Ceiling finishes include suspended acoustic tile and painted gypsum board, bulkheads and fascias.

Laboratory functional equipment to include general fixed building equipment such as toilet room accessories, signage, window blinds, fire extinguishers and cabinets, projection screens, markerboards and tackboards. Allowances are included for storage shelving and millwork, and non-laboratory cabinets and countertops. Also included is laboratory cabinets and countertops (67% included in construction cost, 33% included in Group II/III budgets), laboratory equipment including fume hoods, autoclaves, controlled temperature rooms and general laboratory accessories.

Vertical transportation includes interior stair flights and (2) traction elevators. Roof access is provided by one elevator and one stair.

INCLUSIONS

Plumbing includes sanitary and institutional fixtures (installation and local connection only), floor drains, hose bibbs, water heating equipment, laboratory equipment and distribution pipework, including air, vacuum, deionized water, industrial hot and cold water, special gases, acid waste and neutralization, gas and roof drainage.

Heating, ventilating and air conditioning includes campus fed chilled and steam systems, thermal expansion compensation and circulation equipment, pipework distribution including hot and chilled water, steam/condensate return, equipment cooling, air handling units, including exhaust ventilation, fan-coil units, humidification, terminal boxes and sound attenuation. Air distribution and return, including laboratory exhaust ventilation, building management and laboratory pressurization controls, (7) HEPA filters at radio-isotope hoods and general/laboratory ventilation.

Electrical includes normal power generation and distribution, emergency power generation and distribution, machine and equipment and user convenience power, lighting, telephone/data, audio/visual conduit and cable, MATV, fire alarms and security card-key access.

Fire protection includes a complete automatic wet sprinkler system to the general building and a dry-preaction sprinkler system at the cluster farm.

Site preparation includes an allowance for general site clearing and rough grading.

Site development includes allowances for hard and soft landscaping.

Site utilities include allowances for chilled water and steam, domestic and fire water, gas, sewer, power and telecommunications/signals.

INCLUSIONS

BIDDING PROCESS - MARKET CONDITIONS

This document is based on the measurement and pricing of quantities wherever information is provided and/or reasonable assumptions for other work not covered in the drawings or specifications, as stated within this document. Unit rates have been obtained from historical records and/or discussion with contractors. The unit rates reflect current bid costs in the area. All unit rates relevant to subcontractor work include the subcontractors overhead and profit unless otherwise stated. The mark-ups cover the costs of field overhead, home office overhead and profit and range from 15% to 25% of the cost for a particular item of work.

Pricing reflects probable construction costs obtainable in the project locality on the date of this statement of probable costs. This estimate is a determination of fair market value for the construction of this project. It is not a prediction of low bid. Pricing assumes competitive bidding for every portion of the construction work for all subcontractors and general contractors, with a minimum of 4 bidders for all items of subcontracted work and 6-7 general contractor bids. Experience indicates that a fewer number of bidders may result in higher bids, conversely an increased number of bidders may result in more competitive bids.

Since Davis Langdon Adamson has no control over the cost of labor, material, equipment, or over the contractor's method of determining prices, or over the competitive bidding or market conditions at the time of bid, the statement of probable construction cost is based on industry practice, professional experience and qualifications, and represents Davis Langdon Adamson's best judgment as professional construction consultant familiar with the construction industry. However, Davis Langdon Adamson cannot and does not guarantee that the proposals, bids, or the construction cost will not vary from opinions of probable cost prepared by them.

EXCLUSIONS

Design, testing, inspection or construction management fees

Architectural and design fees

Scope change and post contract contingencies

Assessments, taxes, finance, legal and development charges

Environmental impact mitigation

Builder's risk, project wrap-up and other owner provided insurance program

Land and easement acquisition

Cost escalation beyond a construction midpoint of January 2007

Owner supplied and installed furniture, fixtures and equipment

Loose furniture and equipment except as specifically identified

Growth chambers

Biological safety cabinets, glassware washers and dryers

Hazardous material handling, disposal and abatement

Compression of schedule, premium or shift work, and restrictions on the contractor's working hours

Demolition and removal of existing building structures

Work to streets and sidewalks

CCTV surveillance cameras and monitoring

Audio visual equipment

Atrium smoke ev

Hazardous material handling, disposal and abatement

Compression of schedule, premium or shift work, and restrictions on the contractor's working hours

EXCLUSIONS

Uninterrupted power source (UPS) - by User.

Master antenna TV equipment and cabling

Sump pump and sewage ejector

Public address

Utility tunnel extensions and connections

Underground diesel generator fuel oil storage

Telephone/data "active" equipment, including; hubs, routers, LAN, switches, servers etc.

BSL-3 Suite

Owner sponsored Mechanical and Electrical Commissioning

Additional Functional equipment will be addressed through Group II/III Equipment Budget

Proximity sensors on fume hoods

Fit-out of Cluster Farm

LEED Commissioning

**Genomics Building
University of California, Riverside
Riverside, California**

**DLA 0168-6944
February 9, 2004**

Detailed Project Program Cost Plan

OVERALL SUMMARY

	Gross Floor Area	\$ / SF	\$x1,000
Building	110,321 SF	289.24	31,909
Sitework	75,000 SF	21.75	1,632
<i>TOTAL Building & Sitework, CCCI 4019 (April 2003)</i>			<i>33,541</i>

* Allowance for Rising Costs @ 3.0% PA 11.50% 3,857

<i>TOTAL Building & Sitework with Alternates, January 2007</i>			<i>37,398</i>
---	--	--	----------------------

* Davis Langdon Adamson is recommending an annual rate of 4.0% based on current market conditions.

Please refer to the Inclusions and Exclusions sections of this report

BUILDING AREAS & CONTROL QUANTITIES

Areas

	SF	SF	SF
Enclosed Areas			
Building	110,321		
SUBTOTAL, Enclosed Area		<u>110,321</u>	
Covered area			
SUBTOTAL, Covered Area @ ½ Value			<u>110,321</u>
TOTAL GROSS FLOOR AREA			110,321

Control Quantities

			Ratio to Gross Area
Number of stories (x1,000)	4	EA	0.036
Gross Area	110,321	SF	1.000
Enclosed Area	110,321	SF	1.000
Total Assignable Floor Area	63,986	SF	0.580
Laboratory Assignable Floor Area	45,004	SF	0.408
Non-Laboratory Assignable Floor Area	18,982	SF	0.172
Footprint Area	32,000	SF	0.290
Volume	1,797,136	CF	16.290
Basement Volume	288,000	CF	19.200
Gross Wall Area	76,488	SF	0.693
Retaining Wall Area	10,868	SF	0.099
Finished Wall Area	65,620	SF	0.595
Windows or Glazing Area	21.45% 16,405	SF	0.149
Roof Area - Flat	32,000	SF	0.290
Finished Area	110,321	SF	1.000
Elevators (x10,000)	2	EA	0.181
Plumbing Fixtures (x1,000)	68	EA	0.616
HVAC	220,000	CFM	1.994
Electrical Load	2,000	KW	18.129
Total Site Area	75,000	SF	0.680
Finished Site Area	43,000	SF	0.390

**Genomics Building University of California, Riverside
Building
Riverside, California**

**DLA 0168-6944
February 9, 2004**

Detailed Project Program Cost Plan

BUILDING COMPONENT SUMMARY

		Gross Area: 110,321 SF	
		\$/SF	\$x1,000
1. Foundations		3.21	354
2. Vertical Structure		11.26	1,242
3. Floor & Roof Structures		22.40	2,471
4. Exterior Cladding		29.15	3,216
5. Roofing & Waterproofing		3.06	337
<i>Shell (1-5)</i>		69.07	7,620
6. Interior Partitions, Doors & Glazing		14.00	1,544
7. Floor, Wall & Ceiling Finishes		9.95	1,098
<i>Interiors (6-7)</i>		23.95	2,643
8. Function Equipment & Specialties		28.01	3,090
9. Stairs & Vertical Transportation		6.50	718
<i>Equipment & Vertical Transportation (8-9)</i>		34.51	3,807
10. Plumbing Systems		19.60	2,162
11. Heating, Ventilating & Air Conditioning		51.25	5,654
12. Electric Lighting, Power & Communications		32.72	3,610
13. Fire Protection Systems		3.00	331
<i>Mechanical & Electrical (10-13)</i>		106.57	11,756
Total Building Construction (1-13)		234.10	25,826
14. Site Preparation & Demolition		0.00	0
15. Site Paving, Structures & Landscaping		0.00	0
16. Utilities on Site		0.00	0
Total Site Construction (14-16)		0.00	0
TOTAL BUILDING & SITE (1-16)		234.10	25,826
General Conditions	8.00%	18.73	2,066
Contractor's Overhead & Profit or Fee	4.00%	10.12	1,116
PLANNED CONSTRUCTION COST		April 2003	262.95
Contingency for Design Development	10.00%	26.30	2,901
RECOMMENDED BUDGET		CCCI 4019	289.24
			31,909

**Genomics Building University of California, Riverside
Building
Riverside, California**

**DLA 0168-6944
February 9, 2004**

<i>COMPONENT BUDGETS</i>	<i>Quantity</i>	<i>Unit</i>	<i>Rate</i>	<i>Total</i>
<u>1. Foundations</u>				
Excavation				
Excavate basement and remove	5,333	CY	11.00	58,663
Overexcavation and recompaction of footprint to a depth of 2'	2,370	CY	13.50	31,995
Reinforced concrete including excavation				
Column bases and wall footings	32,000	SF	7.50	240,000
Elevator pits including sump pits	2	EA	7,000.00	14,000
Subsurface drainage				
Perforated drain pipe	604	LF	15.00	9,060
				353,718
<u>2. Vertical Structure</u>				
Columns and pilasters				
Reinforced concrete columns and pilasters	110,321	SF	3.50	386,124
Retaining walls				
Reinforced concrete, 12" thick	10,868	SF	28.00	304,304
Shear bracing				
Reinforced concrete shear walls	110,321	SF	5.00	551,605
				1,242,033
<u>3. Floor and Roof Structure</u>				
Floor at lowest level				
Reinforced concrete slab on grade	32,000	SF	4.50	144,000
Suspended floors				
Reinforced concrete slabs 10" - 15" thick	78,321	SF	20.00	1,566,420
Roofs				
Reinforced concrete slabs 10" - 15" thick	32,000	SF	20.00	640,000
Miscellaneous				

**Genomics Building University of California, Riverside
Building
Riverside, California**

**DLA 0168-6944
February 9, 2004**

<i>COMPONENT BUDGETS</i>	<i>Quantity</i>	<i>Unit</i>	<i>Rate</i>	<i>Total</i>
Miscellaneous metals and rough carpentry	110,321	SF	1.00	110,321
Equipment pads	1	LS	10,000.00	10,000
				2,470,741

4. Exterior Cladding

Wall framing, furring and insulation				
Steel stud framing, gypsum board sheathing, batt insulation	49,215	SF	7.25	356,809
Applied exterior finishes				
Brick veneer with stone trim	49,215	SF	33.00	1,624,095
Interior finish to exterior walls				
Gypsum board, painted	49,215	SF	1.85	91,048
Windows, glazing and louvers				
Aluminum framed insulated window, low-e finish	10,663	SF	45.00	479,835
Aluminum framed insulated curtainwall, low-e finish	5,742	SF	60.00	344,520
Metal louver panels	1	LS	25,000.00	25,000
Exterior doors, frames and hardware				
Aluminum entrances and storefronts	1	LS	25,000.00	25,000
Hollow metal fire exit doors and frames	1	LS	5,000.00	5,000
Fascias, bands, screens and trim				
Sunscreens, canopies and miscellaneous architectural detailing	1	LS	250,000.00	250,000
Soffits				
Cement plaster soffits	1	LS	15,000.00	15,000
				3,216,307

5. Roofing, Waterproofing & Skylights

**Genomics Building University of California, Riverside
Building
Riverside, California**

**DLA 0168-6944
February 9, 2004**

<i>COMPONENT BUDGETS</i>	<i>Quantity</i>	<i>Unit</i>	<i>Rate</i>	<i>Total</i>
Waterproofing				
Elevator pits	2	EA	750.00	1,500
Retaining walls	10,868	SF	4.00	43,472
Insulation				
Rigid insulation under roofing	32,000	SF	2.75	88,000
Roofing				
Built-up roof membrane (energy star)	32,000	SF	4.00	128,000
Roof or deck traffic surfaces				
Walkway pads	1	LS	10,000.00	10,000
Roofing upstands and sheetmetal				
Membrane flashing	1,500	LF	7.50	11,250
Metal parapet flashing	1,000	LF	15.00	15,000
Miscellaneous sheetmetal work	1	LS	15,000.00	15,000
Caulking and sealants				
Miscellaneous caulking and sealants	1	LS	25,000.00	25,000
				337,222

6. Interior Partitions, Doors & Glazing

Partitions and doors				
Metal stud partitions with painted gypsum board lining, sound insulation, wood doors with hollow metal frames, interior glazing	110,321	SF	14.00	1,544,494
				1,544,494

7. Floor, Wall & Ceiling Finishes

Floors				
Sheet vinyl at laboratories and back-of-house areas, ceramic tile at restrooms, carpet at offices and administrative areas	110,321	SF	4.00	441,284
Bases				

**Genomics Building University of California, Riverside
Building
Riverside, California**

**DLA 0168-6944
February 9, 2004**

<i>COMPONENT BUDGETS</i>	<i>Quantity</i>	<i>Unit</i>	<i>Rate</i>	<i>Total</i>
Ceramic tile at restrooms, resilient rubber at general areas	110,321	SF	0.50	55,161
Walls				
Ceramic tile at restrooms, fabric panels at conference rooms, epoxy paint	110,321	SF	1.00	110,321
Ceilings				
Suspended acoustic tile at laboratories, offices and administrative areas, painted gypsum board at restrooms	110,321	SF	4.00	441,284
Miscellaneous				
Special finishes at public lobbies, conference rooms, food services, etc	1	LS	50,000.00	50,000
				1,098,050

8. Function Equipment & Specialties

General building equipment				
Toilet partitions and accessories, code and room identification signage, window blinds, fire extinguisher cabinets, markerboards and tackboards, projection screens	110,321	SF	2.00	220,642
Shelving and millwork				
Storage shelving, janitors' shelving and mop racks, architectural millwork	1	LS	30,000.00	30,000
Cabinets and countertops				
Laboratory spaces				
Base cabinets	2,234	LF	250.00	558,445
Wall mounted cabinets / shelving	1,692	LF	200.00	338,484
Full height storage cabinets	390	LF	400.00	156,000
Countertop, epoxy resin finish (quantity as per RFD)	3,178	LF	90.00	286,063
Countertop, stainless steel (quantity as per RFD)	70	LF	190.00	13,300
Non-laboratory spaces	18,982	SF	5.00	94,910
Special use equipment				

**Genomics Building University of California, Riverside
Building
Riverside, California**

**DLA 0168-6944
February 9, 2004**

<i>COMPONENT BUDGETS</i>	<i>Quantity</i>	<i>Unit</i>	<i>Rate</i>	<i>Total</i>
Laboratory spaces				
Chemical fume hood, 6'-0"	32	EA	7,500.00	240,000
Radioisotope hood	7	EA	13,500.00	94,500
Autoclave	3	EA	90,000.00	270,000
Steam generator	1	EA	15,000.00	15,000
Controlled temperature rooms				
Cold rooms	952	SF	275.00	261,800
Warm rooms	630	SF	275.00	173,250
Miscellaneous laboratory equipment including sinks, emergency eyewash/showers, snorkels, pipe drops, unistrut systems, service piping fittings	45,004	SF	7.50	337,530
				3,089,924

9. Stairs & Vertical Transportation

Staircase flights, floor to floor				
Metal pan stairs with painted steel railings	9	FLT	12,500.00	112,500
Architectural stairs	3	FLT	25,000.00	75,000
Ladders and fire escapes				
Elevator pit and access ladders	1	LS	5,000.00	5,000
Elevators				
Traction				
Passenger, 5 stop	1	EA	250,000.00	250,000
Freight, 6 stop	1	EA	275,000.00	275,000
				717,500

10. Plumbing Systems

Sanitary fixtures and local connection pipework	68	Fx)		
Water closets	24	EA	800.00	19,200
Urinals	8	EA	800.00	6,400
Lavatories	24	EA	700.00	16,800
Service sinks	4	EA	900.00	3,600
Drinking fountains, handicapped	4	EA	2,250.00	9,000
Kitchen sink, garbage disposal	4	EA	650.00	2,600

**Genomics Building University of California, Riverside
Building
Riverside, California**

**DLA 0168-6944
February 9, 2004**

<i>COMPONENT BUDGETS</i>	<i>Quantity</i>	<i>Unit</i>	<i>Rate</i>	<i>Total</i>
Institutional fixtures - installation and local connection only	1	LS	75,000.00	75,000
Sanitary waste, vent and service pipework				
Floor drains and sinks, <= 6"	36	EA	850.00	30,600
Hose bibbs, 3/4"	1	LS	5,000.00	5,000
Rough-in sanitary fixtures	68	EA	2,200.00	149,600
Condensate drainage, < 1"	1	LS	7,500.00	7,500
Reduced pressure backflow preventers, 6"	1	LS	7,500.00	7,500
Water treatment, storage and circulation				
Hot water heating equipment				
Duplex domestic water heaters, Patterson-Kelley, 25 gpm	4	EA	15,000.00	60,000
Circulatory pumps, <= 3/4 hp	2	EA	1,250.00	2,500
Laboratory service equipment				
Air compressor, duplex, dryer, receiver, 25 hp	1	LS	65,000.00	65,000
Vacuum pump, duplex, receiver, valves, muffler and controls, 15 hp	1	EA	55,000.00	55,000
Reverse osmosis and deionized water	1	EA	85,000.00	85,000
Laboratory service piping, valves and insulation				
Including compressed air, vacuum, deionized water, industrial hot and cold water, nitrogen, argon, helium, carbon dioxide, oxygen, lab gas, liquid nitrogen, fume hood connections, accessories, monitors, manifolds, valves, filters and specialties	45,004	SF	24.00	1,080,096
Laboratory waste and vent, including sampling tank	45,004	SF	7.50	337,530
Surface water drainage	1	LS	75,000.00	75,000
Natural gas service	1	LS	35,000.00	35,000
Test purge and sterilize	400	Hr	85.00	34,000
				2,161,926

11. Heating, Ventilation & Air Conditioning

**Genomics Building University of California, Riverside
Building
Riverside, California**

**DLA 0168-6944
February 9, 2004**

<i>COMPONENT BUDGETS</i>	<i>Quantity</i>	<i>Unit</i>	<i>Rate</i>	<i>Total</i>
Heat generation and chilling equipment				
Heat exchangers, hot water, shell & tube, hot water and process steam generation, 10,550 mbth	2	EA	21,750.00	43,500
Chemical water treatment	1	LS	7,500.00	7,500
Thermal expansion compensation and circulation				
Expansion tanks/air seperators	1	LS	7,500.00	7,500
Pumps				
Chilled water, 1,300 gpm, 50 hp	2	EA	12,750.00	25,500
Hot water, 600 gpm, 25 hp	2	EA	9,750.00	19,500
Steam/condensate, duplex, packaged	1	LS	12,500.00	12,500
VFD's	150	HP	450.00	67,500
Vibration isolation	1	LS	15,000.00	15,000
Piping, fittings, valves and insulation				
Chilled, hot water, equipment cooling and steam/condensate systems, including metering	110,321	SF	6.50	717,087
Credit for chilled water associated with cluster farm, including pipework	(1)	LS	30,000.00	(30,000)
Air handing equipment				
Air handling units				
Supply fans, cooling and heating, air filters, variable speed drives, vibration isolation, Temtrol	220,000	Cfm	4.00	880,000
Fan-coil units, 24 hr service, 2 ton - allow	1	LS	15,000.00	15,000
Terminal boxes, with reheat (1/700 SF)	80	EA	750.00	60,000
Humidification, 325 #/Hr	4	EA	11,500.00	46,000
Sound attenuation	220,000	Cfm	0.25	55,000
Air distribution and return				
Galvanized sheetmetal ductwork	165,000	LB	6.00	990,000
Specialty fumehood exhaust ductwork, type 304 - fumehoods to point of dilution only	40,000	LB	12.50	500,000
Exhaust stacks, 10'	1	LS	50,000.00	50,000
Flexible ductwork	3,750	LF	7.50	28,125
Dampers, volume	750	EA	45.00	33,750
Dampers. smoke/fire	1	LS	75,000.00	75,000
Insulation	100,000	SF	2.00	200,000
Diffusers, registers and grilles	110,321	SF	1.00	110,321

**Genomics Building University of California, Riverside
Building
Riverside, California**

**DLA 0168-6944
February 9, 2004**

<i>COMPONENT BUDGETS</i>	<i>Quantity</i>	<i>Unit</i>	<i>Rate</i>	<i>Total</i>
Controls and instrumentation				
Direct digital energy management system	110,321	SF	5.00	551,605
Laboratory controls, variable air volume, Phoenix	45,004	SF	17.75	798,821
Test and balance air/water systems	1,200	Hr	85.00	102,000
Unit ventilation				
General/laboratory exhaust fans	200,000	Cfm	0.75	150,000
Radioisotope fans, 7500 cfm, including HEPA filters	7	EA	12,500.00	87,500
Sound attenuation	1	LS	35,000.00	35,000
				5,653,709

12. Electrical Lighting, Power & Communication

Main service and distribution				
Including dual-ended switchgear, distribution equipment, transformers, motor control & feeders	1,932	KW	300.00	579,600
Emergency power				
Emergency power generator, transfer switches, distribution equipment, transformers, motor control & feeders	682	KW	650.00	443,300
UPS				by Owner
Machine and equipment power				
Connections and switches, including conduit/raceway systems and cable	1	LS	150,000.00	150,000
User convenience power	110,321	SF	5.00	551,605
Lighting	110,321	SF	7.00	772,247
Lighting and power specialties				
Grounding	1	LS	45,000.00	45,000
Lighting control	1	LS	45,000.00	45,000
Cable tray	1	LS	75,000.00	75,000
Clocks	110,321	SF	0.15	16,548
Telephone and communications				

**Genomics Building University of California, Riverside
Building
Riverside, California**

**DLA 0168-6944
February 9, 2004**

COMPONENT BUDGETS

	<i>Quantity</i>	<i>Unit</i>	<i>Rate</i>	<i>Total</i>
Telephone/data outlets, including conduit and cable	878	EA	650.00	570,700
MATV, conduit only	1	LS	10,000.00	10,000
Audio/visual rough-in, including cabling	1	LS	25,000.00	25,000
Alarm and security				
Fire alarm systems	110,321	SF	2.50	275,803
Card-key access, including conduit, cable, hardware and controls	1	LS	50,000.00	50,000
				3,609,803

13. Fire Protection Systems

Automatic wet/dry preaction sprinkler system - complete	110,321	SF	3.00	330,963
				330,963

14. Site Preparation & Building Demolition

0

15. Site Paving, Structures & Landscaping

0

16. Utilities on Site

0

**Genomics Building University of California, Riverside
 Sitework
 Riverside, California**

**DLA 0168-6944
 February 9, 2004**

Detailed Project Program Cost Plan

SITWORK COMPONENT SUMMARY

	Gross Area: 75,000 SF		
	\$/SF	\$x1,000	
1. Foundations	0.00	0	
2. Vertical Structure	0.00	0	
3. Floor & Roof Structures	0.00	0	
4. Exterior Cladding	0.00	0	
5. Roofing & Waterproofing	0.00	0	
<i>Shell (1-5)</i>	0.00	0	
6. Interior Partitions, Doors & Glazing	0.00	0	
7. Floor, Wall & Ceiling Finishes	0.00	0	
<i>Interiors (6-7)</i>	0.00	0	
8. Function Equipment & Specialties	0.00	0	
9. Stairs & Vertical Transportation	0.00	0	
<i>Equipment & Vertical Transportation (8-9)</i>	0.00	0	
10. Plumbing Systems	0.00	0	
11. Heating, Ventilating & Air Conditioning	0.00	0	
12. Electric Lighting, Power & Communications	0.00	0	
13. Fire Protection Systems	0.00	0	
<i>Mechanical & Electrical (10-13)</i>	0.00	0	
Total Building Construction (1-13)	0.00	0	
14. Site Preparation & Demolition	1.73	129	
15. Site Paving, Structures & Landscaping	9.52	714	
16. Utilities on Site	6.36	477	
Total Site Construction (14-16)	17.61	1,321	
TOTAL BUILDING & SITE (1-16)	17.61	1,321	
General Conditions	8.00%	1.41	106
Contractor's Overhead & Profit or Fee	4.00%	0.76	57
PLANNED CONSTRUCTION COST	<i>April 2003</i>	19.78	1,484
Contingency for Design Development	10.00%	1.97	148
RECOMMENDED BUDGET	<i>CCCI 4019</i>	21.75	1,632

**Genomics Building University of California, Riverside
 Sitework
 Riverside, California**

**DLA 0168-6944
 February 9, 2004**

<i>COMPONENT BUDGETS</i>	<i>Quantity</i>	<i>Unit</i>	<i>Rate</i>	<i>Total</i>
<u>14. Site Preparation & Building Demolition</u>				
Site clearing and grading				
Strip and remove asphalt paving	22,500	SF	0.75	16,875
General site clearing and grading	75,000	SF	1.50	112,500
				129,375

<u>15. Site Paving, Structures & Landscaping</u>				
Site improvements				
Hardscape				
Vehicular and pedestrian paving, storm drainage, site lighting	14,190	SF	30.00	425,700
Softscape				
Landscaping including soil amendment, shrubs and groundcover, trees, irrigation, site furniture and signage	28,810	SF	10.00	288,100
				713,800

<u>16. Utilities on Site</u>				
Mechanical				
Chilled water, preinsulated				
8"	400	LF	175.00	70,000
Valves and specialties	1	LS	15,000.00	15,000
Connections to existing	1	LS	15,000.00	15,000
Steam/condensate return, preinsulated				
6"	200	LF	150.00	30,000
2"	200	LF	87.50	17,500
Valves and specialties	1	LS	7,500.00	7,500
Connections to existing	1	LS	7,500.00	7,500
Domestic and fire water				
Underground pipework, fittings				
8"	400	LF	45.00	18,000
Valves and specialties	1	LS	15,000.00	15,000
Metering	1	LS	7,500.00	7,500
Connection to existing	1	LS	5,000.00	5,000

**Genomics Building University of California, Riverside
 Sitework
 Riverside, California**

**DLA 0168-6944
 February 9, 2004**

<i>COMPONENT BUDGETS</i>	<i>Quantity</i>	<i>Unit</i>	<i>Rate</i>	<i>Total</i>
Sewer				
Underground pipework, fittings 8"	400	LF	38.50	15,400
Manholes	2	EA	5,500.00	11,000
Connection to existing	1	LS	3,750.00	3,750
Natural gas, including metering				
Underground pipework, fittings 6"	200	LF	38.50	7,700
Metering	1	EA	5,500.00	5,500
Valves and specialties	1	LS	7,500.00	7,500
Connection to existing	1	LS	3,500.00	3,500
Electrical				
HV switch, 12 KV	1	EA	35,000.00	35,000
Mains power feeder conduit and cable, 12 KV	200	LF	250.00	50,000
Telecommunications/signals concrete encased conduit and cables, (4), 4"	200	LF	75.00	15,000
Connections to existing	1	LS	15,000.00	15,000
Relocate existing 12KV line along Eucalyptus Drive - allow	200	LF	375.00	75,000
Trade deolition, relocation and protection of exsiting utilities	1	LS	25,000.00	25,000
				477,350

**Genomics Building University of California, Riverside
Cluster Farm
Riverside, California**

**DLA 0168-6944
February 9, 2004**

Detailed Project Program Cost Plan

CLUSTER FARM COMPONENT BUDGETS

	<i>Quantity</i>	<i>Unit</i>	<i>Rate</i>	<i>Total</i>
<u>Cluster Farm</u>				
Premium for fit-out cost				
Architectural interior fit-out	500	SF	25.00	12,500
Raised access floor	500	SF	25.00	12,500
Floor drains/trap primers/vents below raised floor	4	EA	850.00	3,400
Chilled water usage	30	tons	1,000.00	30,000
Liebert units, 15 ton	2	EA	27,500.00	55,000
PDU, including panelboards, transformers and feeders	75	KVA	450.00	33,750
Fm-200 fire suppression	1	LS	45,000.00	45,000
Normal and emergency power load				
Normal	68	KW	300.00	20,400
Emergency	68	KW	650.00	44,200
Markups	23.55	%	256,750.00	60,470
				317,220

Appendix D

Building System Criteria

Applicable Codes and Guidelines

The code review presented below is intended only to highlight current applicable code issues and should not be construed as a complete review of all the codes. The Architect is responsible for verifying code issues to ensure compliance with all relevant aspects of the code, since regulations are subject to change.

2001 California Building Code, or most recent edition
2001 Title 24 California State Energy Code, or most recent edition
NFPA 45, 90, 90A and 91, or most recent edition
1996 UCR Campus Design Guidelines - Volume I & 2
1999 UCR Environmental Health and Safety Design Guide
ANSI Standards
ASME Guidelines and Standards
ASHRAE Design Guidelines
SMACNA Design Guidelines
AIHA Guidelines and Standards
CAL/OSHA, current regulations
Requirements for State Fire Marshal
Uniform Plumbing Code, [UPC] current edition
Uniform Mechanical Code, [UMC] current edition
Americans with Disabilities Act

All other local and state codes and the University of California, Riverside standards will be adhered to where applicable and available.

The team met with Scott Corrin, Campus Fire Marshal, who provided the following information:

- Existing/proposed fire hydrants:
 - On Eucalyptus Drive, NE of the University Office Building
 - At the corner of Eucalyptus Drive and Citrus Drive
 - The west side of Citrus Drive, across from Chapman
 - A new hydrant potentially needed on the west side of Citrus Drive, across from Entomology I service court
- Fire and service vehicle access must be maintained on the east side of the proposed site, which is currently a one-way through-street with parking. A minimum width of 20', and a clear height of 13'-6" must be maintained.
- All sides of the building must be within 150' (hose length) of fire truck.
- State fire reviews are in-house.
- The building will be required to have sprinklers, fire alarms, and an independent dry standpipe (if five stories).

- Occupancy will likely be B2, with the possibility of mixed occupancy for other functions.

Occupancy Designation

The building is proposed to be business occupancy “B” for use as a research laboratory facility. The program for the building includes offices and research laboratories (wet). The Conference Center will fall within the assembly occupancy classification Group A-3 which is defined as: “Any building or portion of a building having an assembly room with an occupant load of less than 300 without a legitimate stage, including such buildings used for educational purposes and not classified as a Group E or Group B Occupancy”. Each of these designations should follow standards for construction materials, allowable floor area, building height, fire rating for occupancy separations, the protection of penetrations between spaces, and exiting requirements.

Occupancy Separations

B to A3: None

Construction Type

The maximum allowable area for this site assumes increases in basic allowable area for multi-story buildings, 100% increase for a fully-sprinkled building, and a 100% increase for side yard separations.

Allowable Area

The assumption for the purposes of this DPP is that the Genomics building is Type II-FR construction.

High Rise Requirements

Group B occupancies having floors used for human occupancy more than 75 feet above the lowest level of the fire department vehicle access are classified as high-rise buildings. High-rise buildings are required to be Type I or Type II-FR construction, to have automatic sprinkler protection, and required to meet all the requirements of California Building Code Section 403. These requirements include smoke detection, smoke control, pressurized exit stairs with vestibules, a fire alarm and communication system, a central control station for fire department operations, elevator lobbies, and stand-by-power, light and emergency systems.

For the purpose of this DPP it is assumed that the Genomics building is *not* of high-rise construction.

Architectural Criteria

The following list contributed to the evaluation of the architectural criteria:

1. Applicable building codes
2. UCR planning standards
3. Campus Service Group issues
4. Specific site planning criteria
5. Specific building concept criteria

It is assumed that for the purpose of this DPP, lobby design will *not* require the criteria for an Atrium as described in CBC Section 402 for Atria.

Accessibility

All occupancies shall be fully accessible as required by the California Building Code [CBC], Chapter 11. All building designs will conform to the Uniform Federal Accessibility Standards, #795, April 1, 1998.

Accessible sanitation facilities in all occupancies shall be provided as required in Chapter 11 of the CBC and the Division of the State Architect/Access Compliance requirements of the California Plumbing Code. More information about lab accessibility issues is described in the 3.0 Program section.

Entrances, ramps, stairs, corridors, sidewalks, and walks shall provide accessibility as specified in Chapter 11 of the CBC.

Employee and faculty work areas shall be accessible by means of a 36" minimum aisle width and a 32" minimum clear opening door width, as specified in Chapter 11 of the CBC.

Structural Criteria

Codes

The governing building code will be the California Building Code, 2001 edition. Other referenced design codes are anticipated to include the AISC Manual of Steel Construction (*LRFD*), Second Edition, ACI Building Code, Commentary, ACI 318-99, and AWS Structural Welding Code, ANSI (AWS D 1.1-98).

Design Loads

Live Loads

Laboratories	125 psf, fully reducible for columns and foundations
Offices	100 psf, fully reducible

General Storage	125 psf, non-reducible
Circulation Areas	100 psf, non-reducible
Main Roof (general)	20 psf, reducible
Penthouse Roof	20 psf, reducible

Dead Loads

General:	Estimated weight of construction material
Mechanical Equipment:	150 psf or weight of mechanical equipment

Seismic Design

Seismic design criteria will be based on the latest edition of the California Building Code (2001) and the University of California Seismic Safety Policy, which requires that the building attain a seismic rating of “GOOD”.

Seismic Zone Factor	Z = 0.4
Importance Factor	I= 1.0
Soil Profile Type	S _D C _a = 0.44, N _a = 1.0 C _v = 0.69, N _v = 1.1

Structural System Factor	Will depend on the system selected and will be based on CBC 2001.
--------------------------	---

Wind Design

Basic Wind Speed	90 miles per hour
Exposure	Exposure B
Importance Factor	I= 1.0

Vibration Criteria

Maximum vibration velocity not to exceed 2,000 micro-inches per second under moderate pace walking excitation. Less restrictive vibration criterion for non-sensitive areas such as faculty and student offices, and general administrative support functions may be explored if layout permits zoning such areas together. Such zoning will reduce the structural cost but will also limit future programmatic flexibility of the structure.

Materials

Concrete

- f_c' = 4000 psi Slab-on-grade
- f_c' = 3000 psi Foundations and Piles
- f_c' = 4000 psi Suspended floor slabs and beams

$f'_c = 4000$ psi Columns (non-seismic)

$f'_c = 5000$ psi Shear walls,

Reinforcing Steel

ASTM A615, Grade 60

ASTM A706 in boundary elements of shear walls

Structural Steel

ASTM 992 for all structural shapes except as noted otherwise

ASTM A500, Grade B for all structural tubes

A490 Anchor bolts

A325 High strength bolts, except as noted otherwise

Mechanical Criteria

Applicable Codes, Guidelines and Standards

The latest edition of approved year of the following codes and combination codes and guidelines will govern the Mechanical Systems (wet and dry) and associated support system design. The systems will be designed to meet or exceed these standards. The building design team shall model two or three of the following design options for utilities consumption; steam, chilled water, electricity, natural gas, or city water. Current and expected utility rates shall be used along with life cycle cost calculations in the value engineering decision process. Ventilation on demand (where applicable) and variable air volume with both reheat and recool design strategies along with other options that the design team includes shall be modeled and evaluated.

ABSA	Anthology of Biosafety Facility Design Consideration
AGA	American Gas Association Standards
AIHA	American Industrial Hygiene Association Guidelines and Standards (Latest Edition)
AMCA	Air Movement and Control Association, Inc. Publications 200, 201, 202 and 203 (Latest Edition)
ANSI	American National Standards Institute, Inc.
ANSI/ASME	B31.1 Code for Power Piping B31.2 Code for Pressure Piping B31.3 Code for Process Piping B31.9 Code for Building Services Piping
APHIS	Animal and Plant Health Inspection Service
API	American Petroleum Institute

ARI	Air Conditioning and Refrigeration Institute
ARS	Agricultural Research Service
ASHRAE	American Society of Heating, Refrigerating and Air Conditioning Engineers Handbooks (Latest Editions)
ASHRAE	Standard 62-1989 Ventilation for Acceptable Indoor Air Quality
ASME	American Society of Mechanical Engineers Guidelines and Standards
AWS	American Welding Society
CAGI	Compressed Air and Gas Institute
CAL/OSHA	California Occupational Safety Hazard Authority
CBC	California State Building Code (Uniform Code with CA Modification)
CCR	Title 24 California Code of Regulations
CDC/NIH	Biological Safety in Microbiological and Biomedical Laboratories
CDC/NIH	Primary Containment for Biohazards
CFC	California Fire Code
CGA	Compressed Gas Association
CMC	California Mechanical Code
CTI	Cooling Tower Institute
DHHS	Guide for the Care and Use of Laboratory Animals (U.S. Department of Health and Human Services.)
FCI	Fluid Controls Institute
IAPMO	International Association of Plumbing & Mechanical Officials
IES	Institute of Environmental Sciences (RP-CC Series of Reports) as applicable (Latest Edition)
NAFA	National Air Filter Association Guide to Air Filtration (Latest Edition)
NEBB	National Environmental Balancing Bureau Standards
NFPA	National Fire Protection Association Guidelines and Standards - as applicable to project
SFM	California State and Local Fire Marshall
SMACNA	Sheet Metal and Air Conditioning Contractors National Association, Inc. Guidelines and Standards (Latest Edition)
STI	Steel Tank Institute
UL	Underwriters Laboratories Inc. or equivalent testing lab approved by UC Riverside

All other local and state codes and UC Riverside standards will be adhered to where applicable.

Outdoor Design Conditions

Summer, Riverside per UCR Design Requirements, design will be based on:

Dry Bulb Temperature	110° EF
Wet Bulb Temperature	64° EF

Winter, Riverside per UCR Design Requirements, design will be based on:

Dry Bulb Temperature	34° EF
----------------------	--------

Indoor Temperature and Humidity Design Conditions

The design conditions will be per UCR Facilities Design Guidelines. Final design criteria will be developed during detail design.

Public and Administrative Spaces: Lobby, Gathering and Reception Areas; Office, Conference, and Administrative Support Areas

Dry Bulb Temperature	Summer:	73EF ∇ 2EF
	Winter:	70EF ∇ 2EF
Relative Humidity		No requirement

Research Laboratory and Laboratory Support

Dry Bulb Temperature	Summer:	73EF ∇ 2EF
	Winter:	70EF ∇ 2EF
Relative Humidity		Controlled, 30% to 50%

Instructional Laboratory and Laboratory Support

Dry Bulb Temperature	Summer:	73EF ∇ 2EF
	Winter:	70EF ∇ 2EF
Relative Humidity		No requirement

Insectary Area

Dry Bulb Temperature	Summer:	68-90EF ∇ 2EF
	Winter:	68-90EF ∇ 2EF
Relative Humidity		No requirement

Server/Network Rooms

Dry Bulb Temperature	Summer:	71EF ∇ 2EF
	Winter:	71EF ∇ 2EF
Relative Humidity		40% to 60%

Electrical, VDER, Mechanical and Fire/Security Rooms

Dry Bulb Temperature	Year Round:	85EF Maximum
Relative Humidity		No requirement

Unoccupied Spaces

Dry Bulb Temperature	Year Round:	65 - 95EF
Relative Humidity	No control	

Loading Dock

The loading dock will not be conditioned or ventilated.

Active humidity control will be provided as indicated above. The controlled minimum relative humidity listed above will be maintained within the server/computer rooms by infrared steam humidifiers; in other areas the required humidity levels will be maintained by steam humidification. The maximum relative humidity within these rooms should not be exceeded due to moisture removal at the cooling coils.

Heating and Cooling Loads

Internal

The loads for the mechanical system will be based on the following combined electrical and process loading for the various spaces:

Office, Conference, and Administrative Support Areas

Lighting	1.5 watts per square foot
Equipment	3 watts per square foot

Lobby, Waiting and Reception Areas

Lighting	1.0 watts per square foot
Equipment	0 watts per square foot

Laboratories

Lighting	2.0 watts per square foot
Equipment	12 watts per square foot

Laboratory Support Areas

Lighting	2.0 watts per square foot
Equipment	20 watts per square foot

Server/Network Rooms

Lighting	1.5 watts per square foot
Equipment	20 watts per square foot

Electrical, VDER, and Fire/Safety Rooms

Lighting	0.5 watts per square foot
Equipment	per equipment loads

Unoccupied Spaces

Lighting	0.5 watts per square foot
Equipment	0 watts per square foot

Some of the spaces will have internal loads that exceed the values previously noted. The internal loading for these spaces will be determined based on the electrical and process requirements of the equipment to be located in these spaces.

Occupancy

The occupancy heat rejection will be as follows:

Sensible	255 Btuh/person
Latent	255 Btuh/person

The number of occupants in each space will be based on the actual occupant density listed in the facility program.

Infiltration

The building heat loss calculations will include an infiltration load based on 1.5 CFM of infiltration air per linear foot of exterior wall with windows and 1.0 CFM of infiltration air per linear foot of exterior wall without windows.

Ventilation Loads

The minimum ventilation rates and space classifications for each occupancy type will be as follows:

All Areas

20 CFM outside air per person.

Office, Conference, Administrative and Lobby Areas

Occupied: Minimum air changes per hour as required by ASHRAE Standard 62-1999 for indoor air quality.

Instructional and Research Laboratories

Occupied: Minimum of 8 air changes per hour.
Unoccupied: Not applicable due to 24-hour per day building operation.

Insectary Rooms

10-12 air changes per hour.

Cold Rooms

Occupied: (4) air changes per hour
 Unoccupied: (1) air change per hour

Toilets

Occupied: Minimum 10 air changes per hour
 Unoccupied: Not applicable due to 24-hour per day building operation.

The values listed on the previous page represent minimum values of space airflow for a particular occupancy type. Typical design airflow rates calculated to provide comfort heating/cooling for these areas exceed these minimums. Final airflow values and room air change rates will be determined during the design phase.

Fume Hood Performance Criteria

The fume hoods shall be variable volume type hoods.

In the research laboratories, fume hoods will be equipped with occupancy sensors, sash height sensors, and a one second or less response time (where variable volume hoods are utilized). An appropriate diversity factor will be determined during detailed design. In the laboratories the exhaust system must be designed for 100 percent utilization (100 percent diversity). Coordination of exhaust system sizing, diversity, and excess system capacity should be studied in greater detail during the design phase in order to refine the cost model and to optimize system performance.

The fume exhaust system will be sized with the capacity to produce an average air velocity at the hood face of at least 100 feet per minute (fpm) with a minimum of 70 fpm at any measured point with the sash fully open for standard chemical use. For radioisotope, or regulated carcinogen use, UCR has requested that the hoods be operated with an average linear face velocity of 150 fpm with a minimum of 125 fpm at any measured point. The possibility of reducing the face velocities below 150 fpm will be discussed during the detailed design phase.

4' Chemical Fume Hood (18" sash height)	600 CFM
5' Chemical Fume Hood (18" sash height)	750 CFM
6' Chemical Fume Hood (18" sash height)	900 CFM
8' Chemical Fume Hood (18" sash height)	1200 CFM
4' Radioisotope Hood (18" sash height)	900 CFM

5' Radioisotope Hood (18" sash height)	1125 CFM
6' Radioisotope Hood (18" sash height)	1350CFM
8' Radioisotope Hood (18" sash height)	1800 CFM
Snorkel (3" or 4"N)	100-150 CFM

Indoor Air Quality Control Methods

Indoor air quality will be addressed by four principal means:

- Filtration: 30-40% prefilters and 90-95% final filters at all supply air handling units with space allocated for future charcoal filters.
- Minimum ventilation rates of 8 air changes per hour (ACH) in labs, and 2 ACH in offices throughout the building.
- No fibrous media exposed to the airstream will be allowed in the ductwork downstream of any air handling unit's final filter bank. Sound attenuating flexible ducts at the diffusers will have woven nylon fabric type lining.
- Special lab and support areas will have a HEPA filtration system for up to 99% air filtration.

Outdoor Air Quality Control Methods

Outdoor air intakes will be located to minimize cross-contamination between supply and exhaust air streams. To accomplish this, wind tunnel micro-climate analysis shall be used to evaluate various configurations of fume exhaust stack height, location and position relative to supply air intakes. Air supply exhaust interactions with adjacent buildings shall be carefully studied. Exhaust stack discharge must be vertically upward with a minimum discharge velocity of 3,000 fpm, or as otherwise deemed acceptable via wind tunnel analysis.

Air Handling Unit Component Sizing

Maximum allowable nominal face velocities for all air handling unit components are as follows:

Air Intake Louvres (thru free area)	800 FPM
Hot Water Coils	600 FPM
Cooling Coils	500 FPM
Filters	500 FPM
Sound Attenuators	700 FPM

Duct System Distribution Criteria

- Special Air velocity at occupied levels will be limited to:
General 50 FPM

Laboratory and Support Spaces Near Hood Openings	35 FPM
• Supply Ductwork Sizing (based on undiversified CFM)	
From Air Handling Unit through Chase	0.15"/100' when <10,000 CFM
Chase to Supply Main at each Floor	2,000 FPM when ≥10,000 CFM
• Supply Main to Air Terminal (AT) Device	
	0.15"/100' when <10,000 CFM; 2,000 FPM when ≥10,000 CFM (Duct size to AT device = AT inlet size within 15' of AT)
• Air Terminal Device to Supply Diffuser	
	0.1"/100' when <8,000 CFM
• Miscellaneous Ventilation Systems	
All Ductwork	0.1"/100' when <8,000 CFM; 1,600 FPM when ≥8,000 CFM
• General and Fume Exhaust, and Return Ductwork (based on undiversified CFM)	
Grille to Exhaust Valve (EV)	0.1"/100' when <8,000 CFM; 1,600 FPM when ≥8,000 CFM
Hood or Biosafety Cabinet (BSC) To EV	Equal to air valve size if within 15' of EV
From EV to Branch Main or Main	Equal to EV Outlet Connection size
From Exhaust Branch Main or Main to Chase	0.15"/100' when <10,000 CFM; 2,000 FPM when ≥10,000 CFM
In Chase to Exhaust Air Plenum	0.15"/100' when <10,000 CFM; 2,000 FPM when ≥10,000 CFM
• Miscellaneous Exhaust Systems	
General Exhaust Ventilation	0.1"/100' when <8,000 CFM; 1,600 FPM when ≥10,000 CFM

- Sizing Deviations: Deviations from these criteria will be exercised as deemed necessary for proper air balancing, acoustic control, and duct routing space limitations.

Room Air Distribution

- Offices
 - Titus perforated face diffusers
 - Perforated face return grilles
- Laboratories & Support Spaces
 - Titus perforated face diffuser when $\text{cfm/ft}^2 < 4.5$
 - Krueger TAD diffuser when $\text{cfm/ft}^2 \geq 4.5$
 - Perforated face exhaust grilles
- Others
 - Linear bar grilles or ceiling diffusers as dictated by architectural design and desired performance.

Pipe Sizing Criteria

- Steam
 - Typical: 6,000 fpm maximum velocity
 - In Mechanical Equipment Rooms and Utility Tunnels: 10,000 fpm maximum velocity
- Pumped Steam Condensate
 - 2.5 fps minimum velocity and 6 fps maximum velocity
- Heating Hot Water and Chilled Water
 - 2.5 fps minimum velocity and 10 fps maximum velocity
 - Piping 1" and larger will be sized for a maximum pressure drop of 4 ft. per 100 ft.

Seismic Criteria

Seismic design will be based on SMACNA "Seismic Restraint Manual Guidelines for Mechanical Systems", First Edition, 1991; Seismic Hazard Level "A", Connection level 1.

Equipment mounted on isolators will be seismically braced using loose cables, telescoping pipes or box sections, angles or flat plates used as limit stops or snubbers, either integral to or separate from the isolators. Non-rotating, fixed equipment will be bolted directly to the floor or structure.

Rectangular and flat oval ductwork with a cross-sectional area greater than six square feet and round ductwork with a diameter of at least 28 inches will be restrained, unless suspended by hangers within 12 inches of the supporting structure.

The following piping will be braced:

- All piping in mechanical rooms 1-1/4" and larger, unless hanger length is 6" or less
- All piping 2-1/2" and larger, unless hanger length is 6" or less
- All pipe racks

A seismic brace will be provided at a minimum to every second hanger where the hanger length exceeds 6".

Air Handling Unit Sizing Diversity

- **General**
Airsides diversity will be taken into account for variable air volume systems. Airside diversity will be applied to sizing the air handling units and other associated major equipment, but not applied to sizing any of the ductwork and diffusers. Care must be taken when selecting a diversity factor because if too much diversity is taken, the system will not operate properly and will not allow for future capacity requirements. If too little diversity is taken, costs increase and system efficiency decreases. Therefore, diversity factors will be discussed with the Owner during detailed design. Diversity can be broken down into component parts as shown below.
- **Solar Heat Gain Diversity**
Solar heat gain diversity is normally considered on a variable air volume system, and will be included on this project during the DD and CD phases when a computer heat gain program is run to determine loads. This diversity considers that not all rooms will have peak airflows simultaneously due to changes in the position of the sun. East-facing rooms will peak in the morning in August, west-facing rooms will peak in the afternoon in August, and south-facing rooms will peak in the afternoon in October. The building overall peak is normally in the afternoon in August, but this can vary depending upon building window quantity and orientation.
- **Equipment Heat Gain Diversity**
Additional diversity will be taken for variable air volume heat gain driven rooms, such as the computer-based labs and the Research Labs. Since not all labs will reach their design equipment heat gains simultaneously,

a building overall equipment heat gain diversity multiplier of 75% will be applied during the DD and CD phase computer runs for all heat gain driven rooms.

Piping Systems Criteria

Applicable Codes, Guidelines and Standards

The latest edition or approved year of the following codes or combination codes and guidelines will govern plumbing systems, fire protection, and other piping systems design. The systems will be designed to meet or exceed these standards. The piping systems shall be modeled. The modeling and utility unit costs shall be used in life cycle cost calculations to value engineer pipe sizes and other design criteria.

AGA	American Gas Association
ANSI	American National Standards Institute
ANSI/ASME	B31.1 Code for Power Piping B31.2 Code for Pressure Piping B31.3 Code for Process Piping B31.9 Code for Building Services Piping
ASHRAE	American Society of Heating, Refrigerating and Air Conditioning Engineers Handbooks (Latest Editions)
ASME	American Society of Mechanical Engineers
ASPE	American Society of Plumbing Engineers Databook Guidelines
ASSE	American Society of Sanitary Engineers
ASTM	American Society for Testing and Materials
AWWA	American Water Works Association
CPC	California Plumbing Code
CFC	California Fire Code
FM(x)	Factory Mutual or other Insurance Company as used by Client
IAPMO	International Association of Plumbing & Mechanical Officials
NFPA	National Fire Protection Association
UL	Underwriters Laboratories Inc. or equivalent testing lab approved by UCSD

Noise Criteria

The design will target UCR standards or, if none exists, will use Chapter 37 of the ASPE Databook.

Seismic Criteria

Seismic design will be based on the National Uniform Seismic Installation Guidelines (NUSIG).

- The fire protection piping requiring seismic shall be installed following the non-insulated single hanger or trapeze supported piping methods listed in the NFPA-13.
- Equipment mounted on isolators will be seismically braced using loose cables, telescoping pipes or box sections, angles or flat plates used as limit stops or snubbers, either integral to or separate from the isolators. Non-rotating, fixed equipment will be bolted directly to the floor or structure.
- The following piping will be braced unless hanger length is 6" or less:
 - Gas piping 1" and larger
 - All piping in mechanical rooms 1-1/4" and larger
 - All piping 2-1/2" and larger
- All pipe racks and vertical risers will be braced.
- A seismic brace will be provided at a minimum of every second hanger where the hanger length exceeds 6".
- Insulated and/or non-insulated system as applicable.
- All other local and state codes and UCR standards will be adhered to where applicable and available.

Electrical Criteria

Sustainable and Energy Efficient Design

Building and systems design should consider sustainable design practices and life cycle cost analysis, as a goal, and as referenced in the 2002 draft LRDP.

Applicable Codes, Guidelines and Standards

The latest edition of approved year of the following codes or combination codes and guidelines will govern the Electrical Systems and associated support system design. The systems will be designed to meet or exceed these standards.

ADA	Americans with Disabilities Act Accessibility Guidelines
ANSI	American National Standards Institute, Inc.

CAL/OSHA	California Occupational Safety and Health Administration
CCR	Title 24 California Code of Regulations Energy Commission
IEEE	Institute of Electrical and Electronics Engineers
IESNA	Illuminating Engineering Society of North America
CEC	California State Electrical Code
NECA	National Electrical Contractors Association
NEMA	National Electrical Manufacturers Association
NESC	National Electrical Safety Code
NFPA	National Fire Protection Association
SFM	California State and Local Fire Marshal
CBC	California State Building Code
UL	Underwriters' Laboratories, Inc. or equivalent testing lab approved by UCR

All other local and state codes and UCR standards will be adhered to where applicable and available.

Load Calculation Criteria

Design Voltages

Primary Voltage	12.47 KV, 3 phase, 3 wire
Secondary Voltage	
Normal	480Y/277V, 3 phase, 4 wire 208Y/120V, 3 phase, 4 wire
Emergency/Standby	480Y/277V, 3 phase, 4 wire 208Y/120V, 3 phase, 4 wire

Design Loads

Overall Connected Volt-Amperes (VA) per Square Foot:

Offices

Lighting	1.5
Receptacle	2.0

Seminar Room

Lighting	2.5
Receptacle	10.0

Conference Room-small

Lighting	1.5
Receptacle	5.0

Conference Room-large

Lighting	1.5
Receptacle	8.0

Corridors/Stairs

Lighting	0.8
Receptacle	0.5

Research Labs

Lighting	3.5
Receptacle	20.0

Research Support

Lighting	1.5
Receptacle	35.0

Mechanical Rooms

Lighting	1.5
Receptacle	Actual Motor H.P.

Electrical Rooms

Lighting	1.5
Receptacle	0.5

Network/Server Rooms

Lighting	0.7
Receptacle	50.0

Restrooms

Lighting	0.6
Receptacle	0.5

Telecommunications Room

Lighting	0.7
Receptacle	30.0

* Refer to Electrical Load Calculation Tables located in Appendix E.

Equipment Sizing Criteria

Branch Circuit Load Calculations	
Lighting	Actual connected load
Receptacles	180 VA per outlet
Surface Mounted Raceway	180 VA per outlet
Special Purpose Outlets	Actual connected load
Fixed Equipment	Actual connected load
Motors	125% of full load amps

Demand Factors

Lighting	125% of connected load (continuous load)
Receptacles	100% of first 10 KVA plus 50% of remainder

Fixed Equipment	100% of connected load
Specialty Outlets	100% of connected load
Motors	125% of largest motor plus 100% of all other loads

Minimum Bus Sizes

480Y/277V Lighting Panelboards	100A
480Y/277V Equipment Panelboards	225A
208Y/120V Receptacle Panelboards	225A
480V Motor Control Centers	600A

Distribution panels supplied from K-rated type transformers will have neutral bus sized at 200%.

Distribution panels and branch panelboards will be sized for a minimum of 20% future capacity and space availability.

Feeder Sizes

Feeders supplying to distribution panels will be sized the same as the distribution panel bus size.

Feeders supplying branch panelboards will be sized the same as the branch panelboard bus size.

Feeders supplied from K-rated type transformers will have neutral conductors sized at 200%.

Design Lighting Levels

Average Maintained Footcandles:

Offices, Admin Support	50 (30 indirect)
Research Labs	
Bench & Table Top	70
Elsewhere	50
Lobby/Atrium	20
Conference/Seminar Room	50 - 60
Corridors/Stairs	15 - 20
Network/Server Rooms	35
Restrooms	20
Telecommunications Rooms	35
Electrical/Mech Rooms	
Task	35
General	10 - 20
Exterior Lighting and Pedestrian Pathways	1 - 2

Appendix E

Systems Descriptions

The purpose of this section is to provide an outline of the intended scope for each of the primary building systems under the general categories of Structural Engineering, Mechanical Engineering (including building plumbing), and Electrical Engineering. Each discipline is described in the following narratives.

Structural Systems Description

General

The Genomics building is a four-level structure. The building sits on a site that is sloping down from southeast to northwest. The first floor space, which is accessed from the northwest, is approximately half the size of the typical floor plate. All the laboratories and support spaces in the building are located on the second, third and fourth floors. The laboratories are located along the north and west perimeter of the building. The first floor space is mostly comprised of mechanical and electrical rooms, reception area, large conference room, and circulation space. The total building area is approximately 110,300 gross square feet. For planning purposes, a 16' foot floor-to-floor height is assumed. A laboratory module of 10'-6" by 30'-0" clear has been proposed.

Geotechnical and Geological Condition

The geotechnical investigation report prepared by CHJ, Incorporated dated November 17, 1998 for the adjoining Entomology Building suggests that the site may be underlain by two to seven feet of fill soils. It is anticipated (based on CHJ's report) that all fill within the footprint of the proposed building will need to be removed and recompacted. The report indicates that an additional two feet of soil be removed and compacted below to provide for adequate and uniform support for the structure; however, this will need to be confirmed for the Genomics building site during the design phase.

The proposed site is not within a zone of active faulting. The site is not susceptible to liquefaction hazard or excessive ground motion-induced settlement or instability.

Seismic Design

Seismic design criteria will be based on the latest edition of the California Building Code (CBC 2001) and the University of California Seismic Policy, which requires that the building attain a seismic rating of "good." We have assumed that special seismic performance goals are not required for this project, and the basic seismic design criteria contained in the 2000 Uniform Building Code will guide the design of the seismic system. Accordingly, we did not explore the feasibility of structural seismic system having higher seismic performance characteristics, such as seismic isolation and energy dissipation, since those would require an increase in the project construction budget because of their higher initial construction cost.

Structural Systems

Introduction

The Genomics building is planned as a F.P. II structure, and as such, both concrete and structural steel framing systems can be considered as viable alternatives. Each scheme offers advantages and disadvantages; however, it is anticipated that the building will be of concrete construction because of the strict vibration design requirements, and because of users' favorable experience with other concrete laboratory buildings with similar vibration requirements on the campus.

Concrete systems will have generally better vibration resistance than steel structures because of their increased mass and stiffness. It is more difficult to design a cost-effective steel structural system to meet the vibration criterion of 2,000 micro-inch per second, especially with 30 feet plus clear span between columns. However, concrete structures are generally heavier than steel structures, and result in larger foundations and increased seismic demands. Typically, the structural frame of concrete structures is constructed more slowly than a steel structure. On the positive side, unlike steel construction, concrete framing does not need to be fireproofed.

The following section discusses the various viable concrete structural systems for the Genomics Laboratory Building.

Cast-In-Place Concrete

Gravity System

Within the cast-in-place reinforced concrete systems, several alternate gravity structural systems are viable for this building. This includes a two-way slab system, flat plate system, and one-way slab and beam system. All of these three systems can be made to work with the proposed functional and architectural requirements and the vibration criterion of 2000 micro-inches per second (measured on the floor slab). However, if the proposed laboratory spaces were to be kept column free (i.e., no column can be placed within the lab space which spans 30 plus feet clear), then a one-way slab system at least in the laboratory area would yield the most cost-effective design. The one-way slab system would yield the least heavy of all the concrete schemes. With seismic design forces being directly proportional to the building mass, a reduction in mass, while still meeting the vibration criterion, is desirable since it reduces the cost of the seismic bracing system, as well as the cost of the foundation.

Alternately, a flat-plate scheme may also be explored, although the thickness of the slab required for the 2,000 micro-inch per second is likely to be substantial, unless the column spacing can be reduced in the proposed laboratory spaces (i.e., columns spaced less than 30 feet apart). This may result in a significantly heavier building, which in turn will penalize the seismic design and the foundation design, thus significantly adding to the construction cost. Spacing the columns closer may reduce the slab thickness, but that may not be very desirable, especially in the lab spaces.

Seismic Bracing System

With regards to the seismic bracing system, either concrete shear walls or a concrete moment frame scheme can be used. A concrete shear wall scheme will be significantly less expensive but may limit the architectural and functional layout flexibility. This concern can be mitigated somewhat by locating the shear walls around stairwells, elevator shafts, and/or around the perimeter of the building.

Alternatively, concrete ductile frames could also be used to resist seismic loads. The columns and beams would be substantially larger than those needed for gravity loads, with the columns approaching 30-inches in plan dimension, and girders up to 30 to 36 inches in depth. The size of these members may make it difficult to provide mechanical services to some areas of the building without increasing the floor-to-floor height. Also, the concrete frame system will be significantly more expensive than the concrete shear wall system.

Steel System

As stated earlier, a steel structural system is not believed to be a viable structural system, because of the difficulty in meeting the strict vibration requirements with the 30 feet plus beam span. However, a steel scheme may represent an alternative system that might become more desirable if vibration criteria could be relaxed. Vibration problems are more frequent in steel structures because of their lighter mass and lower stiffness. A steel structural scheme offers the advantage of being significantly lighter than the concrete schemes that would result in smaller foundations, and decreased seismic demands. Typically, the frame of steel structures is constructed more quickly than a concrete structure, although there is substantial lead-time on steel mill orders, and the steel framing needs to be fireproofed.

For the steel scheme, the seismic bracing system would typically be provided by steel brace frames, or steel moment frames. Steel brace frames are generally significantly less expensive than the steel moment frames.

Recommendation

Based on our understanding of the project needs, a concrete building with shear walls for the seismic bracing system, and concrete, one-way slab with beams and girders, appears to be the most viable structural system for the Genomics building. Accordingly, it is the basis for the cost estimate contained in the DPP. The concrete shear wall should be located where it least impacts the architectural and functional space layout, but at the same time works effectively.

The foundation system for the building will consist of spread footings for columns, and continuous footings for the walls. The slab-on-grade is expected to be 5-inch thick throughout, reinforced with rebar for temperature and shrinkage control.

Mechanical Systems Description

Plant Chilled Water System

Chilled water for the building will be provided year round from the central utility plant. It will be extended from the central utility plant, below grade, into the building by means of a pre-insulated pipe and conduit system. We anticipate these pipes to be 8", supply and return. Chilled water distribution in the building will be via a tertiary piping distribution loop, with the tertiary pumps located on the ground floor. Chilled water will be utilized in the building for HVAC cooling.

A two-way control valve will be provided at each point of chilled water use. Speed of variable volume chilled water pumps will be controlled to maintain a preset minimum pressure differential in most remote loop of the building.

Tertiary chilled water supply temperature, set at 46° F, will be maintained by modulating inflow of chilled water into the tertiary chilled water loop. The return water temperature will be 66° F. This system shall be metered. The meter shall communicate with the building's EMC system.

A separate tertiary chilled water distribution loop will provide cooling water to process equipment in laboratories. Possible uses may include:

- growth chambers
- -80° C, freezers
- controlled temperature rooms

Design water temperature will be determined during the schematic phase. This system shall be metered for energy and total flow.

Plant Steam System

Plant steam will be generated by boilers in the central plant. Plant steam will be distributed at a nominal pressure of 45 psig. It will be extended from the central utility plant, below grade by means of a pre-insulated pipe and conduit system, into the building. We anticipate this pipe size to be 6". Plant steam will be utilized for building humidification, for building heating, hot water for preheating of outside air, and for heating of domestic and industrial hot water. Plant steam shall be metered. The meter shall communicate with the building's EMC system.

One pressure reducing station will be provided at a 1/3-2/3 sizing. The station will utilize multiple self-contained, pilot operated, pressure regulating valves.

Steam condensate will be returned to the central plant by steam powered condensate pumps. This pipe size will be approximately two inches. This pipe shall also be piped in a metered, pre-insulated pipe and conduit system.

Central Fume/General Exhaust System

The building will be served by a zoned exhaust system serving fume hood exhaust, snorkel exhaust, and general exhaust requirements of the building. Combined fume and general exhaust duct risers from each floor will connect at the roof level and will be exhausted by at least two centrifugal fans.

The fume exhaust fan stacks for the combined fume and general exhaust fans, one per fan, will discharge at 15 feet above the roof unless determined otherwise by wind tunnel testing.

Sound attenuating devices will be provided at the central exhaust fan's intakes. The exhaust system will operate 24 hours per day, 365 days per year. At least one exhaust fan will be on emergency power.

Pressure independent variable air volume exhaust air terminal devices will be provided to serve general exhaust grilles in lab areas. Pressure independent variable volume exhaust air terminal devices will be provided for the fume hoods. High pressure/high velocity exhaust ductwork will be utilized between the exhaust air terminal devices and the central exhaust plenum. Sound attenuators at the air terminals will not be provided. Instead, sound attenuating flexible ductwork will be provided at general exhaust grilles (but not at hoods) to control noise. In addition, perforated plate dampers will be added at discharge of exhaust air terminals after construction as required to control noise.

A combination indirect evaporative cooling/heat recovery section in the inlet duct to each fan will transfer heat from the exhaust air stream to the outside air stream of each 100% outside air air handling unit to preheat or precool the outside air.

Systems such as this, including laboratory variable air volume (VAV), fan and pump motors employing variable frequency drives (VFDs), high efficiency/high performance motors, air side economizers for air handling units returning air, etc. shall be incorporated into the mechanical design to potentially obtain LEED certification or some lesser form of sustainable systems' design. The design

engineers shall create software models of the building and its system options. The software will predict utility consumption for each option. This information, along with current utility cost rates, will be used in all value engineering design decisions.

Laboratory and Fume Hood Airflow Control Systems

Fume Hood Control

The fume hoods will be exhausted on a variable volume basis.

Laboratory Airflow Control

The laboratories will be non-stepped variable air volume supply and general exhaust with variable volume fume hood exhaust. The control method employed for achieving laboratory air volume control will be airflow tracking type control (i.e. the exhaust rate from the fume hoods and general exhaust will be totaled for each laboratory and the associated supply air valve will be modulated to maintain a predefined offset between the supply and exhaust air quantity). The building's EMC system will monitor room temperature, supply air CFM, general exhaust CFM, fume hood exhaust CFM, fume hood sash height, and fume hood alarm status.

HEPA-Filtered Exhaust Systems

The radioisotope hoods will be served by individual dedicated HEPA-filtered exhaust systems. The exhaust systems will operate 24 hours per day, 365 days per year on a constant air volume basis.

The radioisotope exhaust air will be filtered before discharging into the ambient air. HEPA filters on the exhaust airstream will be located in bag-in/bag-out filter housings on the roof. The filter housings will be sized to accept HEPA, prefilter and charcoal filters. For the isotope hoods, nuclear grade charcoal filters will be added to the housing as required depending on the type of isotope. Safety interlocks shall be incorporated to protect both the operator changing the filters and the researcher at the fume hood. The use of parallel bag-in/bag-out filters will be studied so that the filter to be changed can be isolated without interrupting the operation of the fume hood.

The quantity of HEPA filtered exhaust systems will be confirmed in detailed design.

Cold Room Cooling System

Cold rooms will be designed to maintain 4°C ± 2°C. Humidity levels in the cold rooms will not be actively controlled and should range from 60-90%, non-condensing.

The cold rooms will be cooled by DX type split system unit coolers, which include a refrigerant DX coil and above the room condensing unit. The condensing unit will be air-cooled.

Humidity will be controlled by moisture removal at the cooling coil.

Room temperature will be centrally monitored by the building energy management system and locally monitored by digital recorders at each individual room. Both central and local alarms will be annunciated if the temperature in any room nears a critical level.

Cluster Farm (Bioinformatics) Cooling System

This approximately 500 square foot room will use a raised computer room-type floor for air distribution to remove heat generated primarily from computer equipment (servers, etc.). For a level of redundancy, two chilled, water-cooled, self-contained air conditioning units will be used. The units will be downflow in configuration with air returned to the units at the top. Each unit will provide approximately 60% of the cooling required to satisfy the load. Each unit shall be provided with minimum efficiency filters, microprocessor controls, condensate pumps and infrared humidifiers as required.

Chemical Storage Room Exhaust

A dedicated exhaust system will be provided for each chemical storage room having "H" occupancy. Each system will include a separate exhaust duct and dedicated exhaust fan on the roof.

Combined Preheat/Reheat System

Combined preheat and reheat water convertors will utilize steam from the central utility plant to generate both preheat and reheat water. The steam will pass through a pressure reducing station and will be supplied to the convertors at 30 psig. The preheat and reheat water system will be designed to generate water at 140° F.

Two shell and tube, steam-to-water convertors will be utilized to generate the heating water. Each convertor will be sized to provide 100% of the design load.

The preheat/reheat water piping system will consist of a variable flow water loop. Two base mounted, variable volume pumps will be utilized for the water circulation. Each pump will be capable of providing 100% of the design flow. Variable frequency drives will be provided at the pumps to minimize system pressure fluctuations at varying flow conditions.

A ten percent sidestream water filter will be provided to remove debris from the piping system along with provisions for chemical treatment and water sampling.

Humidification

Plant steam from the central plant will be used for humidification via steam grid, direct injection, duct-mounted humidifiers. Each AHU system will include a humidifier. Humidifiers shall be located at discharge end of each AHU.

Heat Recovery System

An indirect evaporative heat recovery coil at the inlet to each air handler will preheat the outside air in the winter months and precool the outside air in the summer months. Heat will be recovered or rejected in the exhaust air stream via an indirect evaporative heat recovery system. Heat will be transferred between exhaust and outside air units using water/glycol filled piping loop and circulating pump.

Smoke and Fire Control System

The building will not be provided with an engineered smoke control system. Upon smoke detection the air handling units will shutdown, but fume exhaust fans will continue to run to maintain operation of hoods.

Building Central Air Handling System

The building will be served by two different supply air systems: one system for the laboratory, lab support areas and one system for the office areas.

At least two variable volume, custom factory-fabricated air handling units with 2" thick double walls will be utilized for the laboratory system. The office areas will be served by separate recirculated air handling units. All air-handling units will be located on the roof.

The air handling units will be designed as heating-cooling, single duct, steam humidification, reheat type, and where applicable will provide minimum outside air with a 100% outside air economizer on a variable volume basis. The units will operate 24 hours per day, 365 days per year. Supply fans will be plug type.

Variable frequency drives will provide supply and return fan volume control based on a signal from a duct mounted static pressure sensor. Air handling unit supply and return fan speeds will be modulated simultaneously as required by building load. Each air-handling unit will have an indirect evaporative heat recovery coil in the outside air stream. Isolation dampers shall be provided for units with multiple fans so that fans can be maintained while others remain in operation.

The supply distribution system will consist of high-pressure, externally-insulated galvanized steel ductwork with pressure-independent, electrically -actuated supply VAV air terminal devices, reheat coils, low pressure externally insulated ductwork downstream of air terminals, and diffusers. There will be no lined ductwork on the project. Sound attenuators at the air terminal devices will not be provided. Instead, sound attenuating flexible ductwork with woven nylon fabric type lining will be provided at the supply diffusers to control noise. In addition, perforated plate dampers will be added at the inlet of supply or exhaust air terminals after construction as required to control noise.

Ductwork will be constructed in accordance with California Medical Code and SMACNA standards; duct leakage shall not exceed 1% of the design volumetric flow rate for high pressure ductwork and 2% for low pressure ductwork. The use of sound attenuating flexible duct at diffusers and grilles will be limited to six feet in total length to minimize duct static pressure losses.

Supply air will be distributed through riser duct(s) and horizontal main ducts on each floor. Generally, there will be one temperature control zone for each laboratory and one zone for each office.

Building Automation and Control System

The utility and environmental air systems will be controlled and monitored through a Direct Digital Control (DDC) based Energy Management Control System (EMCS) with distributed processing.

System design will be modular and flexible. The major system components of the EMCS include fully stand-alone application controllers, network controllers, and computer workstation.

The controllers are networked to share information, and control the management function without sacrificing stand-alone reliability. An operator interface terminal may be connected to any of the controllers to operate the network.

A personal computer (PC) with printer will be tied into the networked controllers so that information can be accessed from a central location within the building.

The EMCS shall communicate with a workstation in the central utility plant.

Commissioning

If the Campus decides to pursue LEED certification, each mechanical (plumbing and HVAC) system shall be commissioned. The cost for commissioning as defined by LEED is not in the current budget. Commissioning should start with the design schematic phase and continue through construction.

Commissioning agents should review construction submittals along with engineers and work with engineer and University to develop compliance testing of all systems and components, access verification documents, and training required for operating, repair, and maintenance of all mechanical systems. The commissioning agents shall design compliance testing procedures and documentation forms. They shall schedule and oversee all testing and report the results to the University's agent.

Mechanical Equipment Schedule

Equipment	Manufacturer	Size (Each)	Total Quantity	Quantity Operating During Emergency Power
Air Handling Unit	Temtrol	55,000 CFM @ 7" SP, 100 HP	4	2
Exhaust Fan	Bary	50,000 CFM @ 5" SP, 60 HP	4	2
Exhaust Fan (Radioisotope Hoods)	Bary	7500 CFM @ 3" SP, 5 HP	7	4
Humidification	Armstrong	1,300 MBH	Yes	-
Shell and Tube Heat Exchanger for Hot Water Conversion	Bell & Gossett	10,550 MBH	2	-
Chilled Water Pumps	Bell & Gossett	1,300 GPM @ 100 ft. Head 50 HP	2	1
Hot Water System Pumps	Bell & Gossett	600 GPM @ 100 ft. Head 25 HP	2	1
Steam Condensate Pumps	Spirax/Sarco	Steam Powered	1 Package, Duplex Pumps	-
*Computer Room A/C Units	Liebert	15-Ton, 6,000 CFM, 3 HP Fan Motor	2	2

Mechanical Utilities:

8" Chilled Water Supply/Return in and out of building (8" CHWS&R).

6" High Pressure Steam (45 psig) into building (6" HPS (45)).

2" Pumped Condensate Return out of building (2" PCR).

*Liebert Units Located in Cluster Farm.

Piping Systems Description

Domestic Hot and Cold Water (Potable)

Potable hot and cold water will be provided for all toilet rooms, showers, emergency shower/eyewash units, and all other fixtures and devices that require a potable water supply. Building cold water source will be extended from the existing campus water distribution system in the street.

Once inside the building, the water service main will branch out with two (2) cold water mains, one (1) for potable water, and one (1) with a reduced pressure backflow preventer (RPBP) to serve the industrial water system. A duplex (hi/lo) readout water meter will be installed immediately upstream of both cold water mains. The meters will communicate to the building's EMS to track consumption.

Duplex pressure reducing valve assemblies will be provided upstream of the potable and industrial water service. Campus water pressure is above 80 psi. These pressure reducing valves will be sized as follows: one (1) for 75% of the total design flow, and one (1) for 33% of the total design flow.

Duplex steam-to-water, water heaters, double-walled, will be provided to produce 120°F domestic hot water system. The domestic hot water system will be circulated back to the water heaters with the use of a circulating pump and aquastat.

The potable hot and cold water distribution piping will be sized for a maximum velocity of 7 fps. Water conservation faucets and fixtures will be utilized to meet and/or exceed required code minimums.

A separate potable tepid water system will supply the emergency shower/eyewash fixtures and handheld eyewash units. This supply line to the emergency showers will be monitored by an in-line flow switch, connected to an audible alarm and building security system for 24-hour monitoring or other location(s) as directed by the University Representative.

Water conserving fixtures and fittings shall be incorporated into the plumbing design to potentially obtain LEED certification or some lesser form of sustainable systems' design.

Industrial Hot and Cold Water (Non-potable)

Industrial hot and cold water will be provided to serve all laboratory and process-related equipment, lab sinks, cup sinks, and other devices that require an industrial water supply. Industrial cold water will also serve HVAC equipment as required. The industrial cold water distribution system will be isolated from the potable system by providing a reduced pressure backflow preventer (RPBP's) at source point.

Duplex steam to water, water heaters (single-walled), will be provided to produce 140°F industrial hot water system. The industrial hot water system will be circulated back to water heaters with the use of a circulating pump and aquastat.

Glass washing and autoclave equipment will be installed with water conservation controls.

Pure Water System

The anticipated requirements for the distributed purified water system for the building is CAP Type I. This requirement shall be confirmed by the laboratory users.

The pure water system will be fed from the existing campus DI water where available, otherwise DI water will be generated at the building. The water to the building will be metered and the meter will communicate to the building's EMS for consumption monitoring.

The equipment for the system will include; FDA epoxy-lined fiberglass tank; hydrophobic, 0.2-micron tank vent filter; 316L stainless steel centrifugal distribution pump; resistivity monitored mixed bed exchange columns; hydrophilic, 0.45-micron water filter; 254-nanometer and 185-nanometer ultraviolet lights, and hydrophilic, 0.2-micron water filter.

Acceptable materials for the pure water distribution system will be butt-welded schedule 80, unpigmented, flame retardant polypropylene piping and fittings.

The polypropylene piping will be continuously supported in a hung "V" channel, with 1/8"/ft slope in the direction of flow. Horizontal expansion loops will be installed in any straight run longer than 100 feet. Distribution system will employ individual loops dedicated for each floor. Dead legs in the distribution system shall be avoided. Where unavoidable, they will not be longer than six (6) times the inner diameter of the distribution piping.

Points of use will utilize a pipe U-bend with a bottom outlet connected to a manual type “zero” dead leg diaphragm valve with bottom outlet. The supply and return pipes will drop within the utility chase at the peninsula and island benches or at wall for other required locations.

System monitoring and/or control will be deemed acceptable by UC Riverside design guidelines by using a PLC in a local control panel. The local control panel will have indicators for the tank level, system resistivity, system TOC, and loop flow rate. The local indicators for the tank level, resistivity, and TOC will have capacity to send discrete alarm signals.

Velocities through distribution system shall be limited to 3 to 7 feet per second.

Laboratory Compressed Air

A duplex air compressor assembly will be provided at the building.

The system downstream of filter and dryer will be distributed at 100 psig. The 100 psig system will be reduced so that a 80 psig system or as directed by UCR serves the building at each floor level. Only one (1) laboratory compressed air main riser will rise up through the building. From this main riser, all system branches on each floor will be extended. Other PRV stations can be provided to regulate pressure for other desired settings if necessary.

The distribution system will be sized so that the uniform friction loss does not exceed 10% to 13% of the delivered pressure and the velocity does not exceed 4,000 fpm.

The system will be assumed to deliver 1 CFM per outlet (turret).

Laboratory Vacuum

A duplex laboratory vacuum pump assembly will be provided at the building.

The depth (pressure required), of the laboratory vacuum system will be verified during the schematic phase.

The system will be assumed capable of extracting 0.5 SCFM at each lab inlet (turret) at 24” of vacuum. The piping system will be sized to maintain an approximate (constant) overall system pressure loss of 2” Hg, without exceeding a velocity of 4,000 fpm.

Specialty Gases

Specialty gases (oxygen, carbon dioxide, nitrogen, etc.), of types as necessary, will be furnished and maintained by the individual user groups within the laboratories under a separate service contract.

A central CO₂ system is anticipated for cell culture rooms. Unless a larger demand is expected, high pressure gas cylinders will be provided with automatic switchover manifold. CO₂ will be distributed at 80 PSIG and reduced at the point of use.

The distribution system will be sized so that the uniform friction loss does not exceed 5% to 10% of the delivered pressure and the velocity does not exceed 4.000 fpm.

Natural Gas

Natural gas will be distributed centrally throughout the building. Laboratories will be supplied with low pressure gas at 7" W.C. (0.25 PSIG).

The natural gas will be supplied by a campus loop. It will be extended into the building. Natural gas will be metered. The meter will communicate with the building's EMS for consumption tracking.

Fire Protection

All areas of the building will be fully sprinklered by a total coverage, hydraulically designed automatic wet sprinkler system, based on Ordinary Hazard, Group II, with a maximum sprinkler head spacing of 130 square feet. The fire protection system that will serve the new building, will be supplied from the campus fire main distribution system, via a detector check valve and post indicating valve. The use of a fire department siamese hose connection at building wall will also be required. The new system will be supplied by a 6" water main to the building that is part of the new 8" cold water main that will be extended from the campus main. The 6" main will serve a combination standpipe system in building for wet sprinklers with 2-1/2" (Class I) fire hose valves and 1-1/2" adapter. Each floor will be considered a separate zone. An independent dry standpipe system will be required if building is more than four stories high.

Fire Protection Cluster Farm (Bionformatics)

This approximately 500 square foot room will use a raised computer room type floor for air distribution and cable routing. An FM200 fire suppression system and/or a preaction sprinkler system is expected to be required for this room. The preaction sprinkler system will be supplied by the 6" water main for the automatic wet sprinkler system.

Sanitary Waste

A sanitary waste and vent system will be provided for sanitary waste-producing fixtures and equipment including a Cluster Farm. All fixtures will be individually trapped and vented.

The building sanitary sewer system will flow by gravity to a location 5'-0" beyond the building exterior. It will then be extended from the building to the campus sanitary sewer system under civil scope of work.

Storm Water

A storm water drainage system will be provided for the building to convey rain water from primary and overflow roof drains.

The building storm water drainage system will flow by gravity to a location 5'-0" beyond the building exterior. It will then be extended to the campus main under civil scope of work. Overflow roof drains will spill to grade with the use of downspout nozzles at termination points.

Laboratory Waste

Laboratory waste is produced by lab sinks, cup sinks, laboratory floor drains and lab appliances and equipment. It is assumed that lab waste is primarily clear water from washing, rinsing and dilution functions, generally without solids. The laboratory waste effluent will be chemically neutralized prior to discharge to the campus sanitary sewer system.

Commissioning

If the Campus decides to pursue LEED certification, each piping system shall be commissioned. The cost for commissioning as defined by LEED is not in the current budget. Commissioning should start with the design schematic phase and continue through construction. Commissioning should start with the schematic phase and continue through construction. Commissioning agents should review construction submittals along with engineers and work with engineer and University to develop training required for operating, repair, and maintenance of piping systems. The commissioning agents shall design compliance testing procedures and documentation forms. They shall schedule and oversee all testing and report the results to the University's agent.

Piping Equipment Schedule

Equipment	Manufacturer	Size (Each)	Total Quantity	Remarks
Duplex Domestic Water Heater(s)	Patterson-Kelley	25 GPM	2	One unit is for standby
Duplex Industrial Water Heater(s)	Patterson-Kelley	100 GPM	2	One unit is for standby
Domestic Hot Water Circulating Pump	Grundfos	≤3/4 HP	1	Aquastat control
Industrial Hot Water Circulating Pump	Grundfos	≤3/4 HP	1	Aquastat control
Duplex Laboratory Air Compressor Assembly (including Dryers and Receiver)	AirTech	25 HP each	2	One unit is for standby
Duplex Laboratory Vacuum Pump Assembly (including Receiver)	AirTech	15 HP each	2	One unit is for standby
Pure Water Make-Up System: Multi-media filter, softener, activated carbon filter, RO prefilter, 5 GPM RO system, mixed bed, UV, 0.2 micron filter	Ionics	---	1	
Pure Water Distribution Loop: 1,000 gallon tank, distribution pump, 30 GPM/95 PSI, 5 HP UV, 0.2 micron filter	Ionics	----	1	
FM200 Fire Suppression System	Kidde-Fenwal	----	1 Zone	For Cluster Farm (Bioinformatics)
Preaction Sprinkler System	Viking	----	1 Zone	For Cluster Farm (Bioinformatics)

- Notes:
1. Equipment size at this juncture is "roughly" estimated, based on similar size and type projects.
 2. Water heaters are steam-to-water (compact) units.
 3. Circulating pump(s) will be controlled by aquastat(s) to maintain service temperature.
 4. Domestic (potable) hot water will serve lavatories, non-lab sinks, janitors closets, shower stalls, etc., and would be set at 130°F leaving, 120°F flowing.
 5. Industrial (non-potable) hot water will serve lab sinks, lab equipment requiring hot water, etc., and would be set at 150°F

Electrical Systems Description

Normal Power Service and Distribution System

The Genomics Building will be served with electrical power from existing underground campus 12.47-kV primary distribution system. Provide new ductbank with two new 15 kV feeders from a future vault located in Citrus Drive to a new double-ended secondary unit substation located in the main electrical room of Genomics Building. The 15 kV feeders will be installed in 2-5" PVC conduits, red concrete encased ductbank with 36" cover, per UCR Unit Substation Standard 16310. The future vault shall be installed under a separate contract prior to this project. Vault location shall be verified with University in detailed design. All of the electrical power to the building will be metered for kWh consumption. The meter(s) will communicate to the building's EMS for electrical energy tracking.

The double-ended unit substation shall consist of two 1000-kVA cast coil, dry-type, 12.47 kV-480/277V, 3-phase, 4-wire transformers. Size of transformers and location of selector switch (in vault or in substation) to be determined in future detailed design.

Access manholes will be spaced at approximately 400 feet as necessary.

Building electrical equipment will distribute power to loads as follows:

480V, 3 phase, 3 wire	Motors 1/2 HP and larger
480Y/277V, 3 phase, 4 wire	Fluorescent lighting, large laboratory equipment
208Y/120V, 3-phase, 4-wire	Receptacles, specialized lights, motors under 1/2 HP and small equipment

All circuit breakers in the double-ended unit substation will be drawout-type and will have ground fault protection. The main circuit breakers and tie breaker will be key interlocked to prevent paralleling of the service transformers. All main circuit breakers will be capable of remote trip via a keyed switch to be located at the designated fire department entrance. The key to this switch will be contained in a lockbox adjacent to the switch access to which shall be by the fire department only. The main circuit breakers and the tie breaker shall communicate their status (open/closed) back to the building's EMS system.

The double-ended unit substation will feed 480Y/277 volt lighting and power panels and dry type 480-208Y/120 volt distribution transformers, which will be located in floor electrical rooms. These transformers will feed 208Y/120 volt secondary distribution switchboards located in the floor electrical rooms

208Y/120 volt branch panelboards will be located in laboratories, floor electrical rooms, or non-rated corridors on the same floor as area served. Laboratory branch panelboards shall have main circuit breakers and will be located in the laboratory area served to minimize branch circuit length. One panelboard will serve 2 to 4 laboratory modules.

The unit substation will also provide power to motor control centers (MCCs), which will serve mechanical motor loads. MCCs will be located in proximity to the equipment being served.

A TVSS will be installed at all 208Y/120V distribution panelboards.

During detailed design, the use of photovoltaics shall be investigated. Different percentages of renewable power shall be evaluated for initial budget cost verses life-cycle payback. This analysis shall be presented to the University for their assessment for use in this project.

Standby/Emergency Service and Distribution System

Standby/Emergency power will be provided by an on-site diesel engine generator set and distributed as follows:

Emergency Power (required by code)

480Y/277V, 3 phase, 4 wire	Emergency egress and exit lighting
208Y/120V, 3-phase, 4-wire	Fire alarm, data, video and voice.
Standby Power (not legally required)	
480V, 3 phase, 3 wire	Motors 1/2 HP and larger
480Y/277V, 3-phase, 4-wire	Fluorescent lighting, large laboratory and mechanical equipment
208Y/120V, 3-phase, 4-wire	Receptacles, motors under 1/2 HP, small equipment and security

There will be a 600-kW/750 kVA emergency generator connected to the unit substation (sizing to be confirmed during schematic design). The generator will provide power at 480Y/277 volt, 3 phase, 4 wire. The generator will be located exterior to the building in close proximity the main electrical room. This is based on UCR Standard Emergency Electrical Generator Set 16620.

Exterior emergency generator will consist of engine generator and controls, UL listed fuel tank, exhaust system, radiator, batteries, starting system, output circuit breaker, and a sound attenuated weatherproof enclosure. Generator fuel supply shall have the capacity to operate the generator at full load rating as required by state and local codes.

Automatic transfer controls will be via automatic transfer switches and will be located in main electrical room. All emergency life-safety loads will be physically separated and supplied through a separate automatic transfer switch and an independent distribution system from the standby loads. This is based on UCR Standard Automatic Transfer Switch 16609.

The emergency/standby power will be distributed to two automatic transfer switches, one for life-safety loads, and one for standby loads. These switches will feed independent distribution switchboards, which will be located in the main electrical room.

Emergency power distribution transformers will be located on floor electrical rooms to transform voltage from 480V to 208Y/120V between the emergency lighting panels and the emergency branch circuit panelboards. Emergency power should be connected to egress lighting and exit signs, elevator, fire alarm system, and other code related life-safety equipment.

Standby power should be connected to select air handlers, exhaust fans, hot water system, and chilled water pump as noted in the Mechanical Equipment Schedule.

Standby power distribution transformers will be located on floor electrical rooms to transform voltage from 480V to 208Y/120V between the standby equipment panelboards and the standby branch circuit panelboards. Standby power should be connected to critical research equipment, refrigerators, freezers, temperature controlled rooms, growth chambers, Cluster Farm (Bioinformatics), vacuum pumps, monitoring equipment, a minimal number of receptacles in

each laboratory, select room ventilation systems, and select room lighting. Two 120V, 20A, 1 phase circuits in each laboratory and laboratory support space will be on standby power.

Cluster Farm (Bioinformatics) will be served with a dedicated Power Distribution Unit (PDU).

Emergency generator will be sized for sufficient capacity to carry common utilities, plus 20% spare capacity.

Uninterruptible Power System (UPS)

It is anticipated that the type of system to provide a clean and uninterruptible source of power for the laboratories will be by independent point-of-use units purchased and installed by the users.

Grounding System

A building grounding system will be designed in accordance with NEC article 250 and will be based on equi-potential grounding with voice/data system bonded to the building ground system. System resistance to ground will be 5.0 ohms or less.

All parts of the power distribution system will be provided with an equipment ground conductor. This system will extend from the building service transformers to the branch circuit load or device. Grounding electrode system will include underground water lines, structural steel, and ground ring supplemented with driven ground rods.

Specialty grounding consisting of under-floor grounding will be provided for Cluster Farm (Bioinformatics).

Lighting Systems

A complete lighting system for all indoor and site illumination will be provided. The indoor lighting system will consist of energy efficient fluorescent fixtures with electronic ballasts. Incandescent lamps will be limited to areas requiring special dimming only.

The outdoor lighting system will consist of high intensity discharge (HID) fixtures. Site lighting fixtures will be specified to match existing University standards.

Exterior light pollution reduction, photocell controlled exterior and interior lighting, solar powered exterior lighting, access to daylighting, daylight harvesting, occupancy sensor controlled interior lighting, and automated lighting control shutoff shall in some form be incorporated into the lighting design to potentially obtain LEED certification or some lesser form of sustainable systems' design.

In general, indoor lighting controls will consist of low voltage switches controlled by an automated lighting control system, room occupancy sensors, and photocells controlling daylight internal spaces. Occupancy sensors shall control enclosed offices, conference rooms, restrooms, janitor closets, and any other enclosed areas that may be subject to private limited use. The automated lighting control system will be integrated through the BMS system. The lighting shall remain ON from 7 am to 7 pm, typically. Outdoor lighting controls will utilize photocells and time switches with line voltage manual override switches. This is based on UCR Standard Lighting Fixtures 16510.

Unswitched branch circuits will provide emergency/night lighting. These unswitched branch circuits will be fed from emergency lighting panel.

Information System

Telecommunication infrastructure will comprise of backboxes, conduits, cable tray, and backboards for equipment mounting and cable plant installation.

Telecommunications service to the building will be installed with four 4-inch underground conduits from the existing telecommunications manhole in Citrus Drive. Existing manhole location and quantity of conduits required shall be verified with University in detailed design.

Each floor will be served by a minimum of one Intermediate Distribution Frames (IDF) located on the floor, vertically stacked between floors. During detailed design, exact quantity of IDF rooms per floor will be determined.

The telephone/data system will consist of wall outlets in all occupied spaces, such as offices, labs, conference rooms, etc. These outlets will be connected to the MDF and the IDFs via conduit and cable tray system.

Cluster Farm (Bioinformatics) will be provided with under-floor cable management system.

The system requirements and configuration will be further determined during detailed design.

Fire Alarm System

The fire alarm system will be an electronically multiplexed addressable type detection, alarm and voice communication system. Remote transponder panels will be used to provide supervised amplifiers and signal circuits for audio/visual devices and magnetic door holders. The system is based on UCR Standard Fire Detection and Alarm System 16720.

The building will have complete smoke detection coverage. The system will utilize individual addressable photoelectric smoke detectors, heat detectors, addressable manual pull stations, and addressable monitor and control modules. The system will monitor all sprinkler supervisory and water flow switches and will interface with elevators, HVAC smoke control and smoke fire damper, FM200 and/or preaction systems for the Cluster Farm (Bioinformatics). Audio/visual devices shall be installed in all areas of the building in accordance with NFPA and the ADA guidelines.

A reverse-polarity module will be provided for transfer of system alarm and trouble signals to the UCR Central Fire Alarm Console via campus fire alarm proprietor cable plant, with connection point at the fire alarm control panel. A new fire alarm fiber cable in conduit will be installed to the building from an existing fire alarm splice box. Existing splice box location to be verified with University in the detailed design.

Security System

The security systems will consist of an intrusion detection system, a door access and control system and a closed circuit video surveillance system.

University will provide all equipment and wiring under separate contract. The electrical contractor will provide backboards for equipment, conduit, cable tray and back boxes only.

The security system requirements and configuration will be further determined during detailed design.

Commissioning

If the Campus decides to pursue LEED certification, each electrical system shall be commissioned. The cost for commissioning as defined by LEED is not in the current budget. . Commissioning should start with the design schematic phase and continue through construction.

Commissioning should start with the design schematic phase and continue through construction.

Commissioning agents should review construction submittals along with engineers and work with engineer and University to develop training required for operating, repair, and maintenance of electrical systems. The commissioning agents shall design compliance testing procedures and documentation forms. They shall schedule and oversee all testing and report the results to the University's agent.

Electrical Load Calculations

<i>ELECTRICAL LOAD ESTIMATE</i>	NORMAL POWER			STANDBY / EMERGENCY POWER		
	Normal Connected kVA	Demand Factor	Normal Demand kVA	SB/Emer Connected kVA	Demand Factor	SB/Emer Demand kVA
LIGHTING	175.7	125%	219.7	22.2	125%	27.8
RECEPTACLE AND EQUIPMENT	1218.4	First 10kVA @ 100% Remainder @ 50%	614.2	390.4	First 10kVA @ 100% Remainder @ 50%	200.2
MECHANICAL MOTORS	835.9	100%	835.9	423.7	100%	423.7
MISCELLANEOUS @ 1.5VA/SF	165.5	100%	165.5	16.5	100%	16.5
TOTAL kVA ELECTRICAL LOADS	2395.5		1835.2	852.8		668.2
TOTAL WATTS PER SF	17.4		13.3	6.2		4.8

LIGHTING								
Index	SPACE TYPE	QTY	ASF	Total ASF	Connected VA/SF	Normal Connected kVA	% Emergency	Emergency Connected kVA
GENOMICS RESEARCH LABORATORIES								
2.01	Research Labs - Open and Cellular (modules)	93	315	29,295	3.5	102.53	10%	10.25
2.02	Bioinformatics	4	400	1,600	3.5	5.60	10%	0.56
Laboratory Subtotal				30,895		108.13 kVA		10.81 kVA
GENOMICS RESEARCH SUPPORT								
3.01	Equipment Room	6	315	1,890	1.5	2.84	10%	0.28
3.02	Dark Room	1	105	105	3.5	0.37	10%	0.04
3.03	Autoclave Glasswash	3	473	1,419	3.5	4.97	10%	0.50
3.04	Radioisotope Room	7	158	1,106	3.5	3.87	10%	0.39
3.05	Growth Chambers/Equipment Room	3	315	945	1.5	1.42	10%	0.14
3.06	Insectaries	3	210	630	3.5	2.21	100%	2.21
3.07	Arabidopsis Rooms	3	210	630	3.5	2.21	100%	2.21
3.08	Cell Culture Room	14	210	2,940	3.5	10.29	10%	1.03
3.09	Fume Hood Alcove/Chemical Storage	32	84	2,688	1.5	4.03	10%	0.40
3.10	Cluster Farm (Bioinformatics)	1	500	500	1.50	0.75	100%	0.75
3.11	Controlled Temperature Room (+4 deg. C)	8	119	952	3.5	3.33	10%	0.33
3.12	Cryo Storage	2	105	210	1.5	0.32	10%	0.03
Lab Support Subtotal				14,015		36.59 kVA		8.3 kVA
GENOMICS OFFICE/ADMIN/CONF								
4.01	Faculty Office (PI)	36	132	4,752	1.5	7.13	10%	0.71
4.02	Post-doctoral Scholars	72	60	4,320	1.5	6.48	10%	0.65
4.03	Graduate Students	108	40	4,320	1.5	6.48	10%	0.65
4.04	Administrative Support	6	120	720	1.5	1.08	10%	0.11
4.05	Work Study Student	5	40	200	1.5	0.30	10%	0.03
4.06	Faculty Colloquium	1	145	145	1.5	0.22	10%	0.02
4.07	Copy/Mail/Workroom	1	269	269	1.5	0.40	10%	0.04
4.08	Conference	4	264	1,056	1.5	1.58	10%	0.16
4.10	Conference Facility (Dean's Office)	1	2730	2,730	2.5	6.83	10%	0.68
Office/Admin Subtotal				18,512		30.5 kVA		3.05 kVA
BUILDING SUPPORT								
5.01	Loading Dock	1	300	300	0.8	0.24	10%	0.02
5.02	Telecommunication/Server	2	132	264	1.0	0.26	10%	0.03
Building Support Subtotal				564		.5 kVA		.05 kVA
PROGRAM TOTAL ASF				63,986		175.72 kVA		22.22 kVA
TOTAL BUILDING GSF				110,321				

RECEPTACLES								
Index	SPACE TYPE	QTY	ASF	Total ASF	Connected VA/SF	Normal Connected kVA	% Emergency	Emergency Connected kVA
GENOMICS RESEARCH LABORATORIES								
2.01	Research Labs - Open and Cellular (modules)	93	315	29,295	20.0	585.90	10%	58.59
2.02	Bioinformatics	4	400	1,600	20.0	32.00	10%	3.20
Public Space Subtotal				30,895		617.90 kVA		61.79 kVA
GENOMICS RESEARCH SUPPORT								
3.01	Equipment Room	6	315	1,890	35.0	66.15	100%	66.15
3.02	Dark Room	1	105	105	35.0	3.68	25%	0.92
3.03	Autoclave Glasswash	3	473	1,419	35.0	49.67	10%	4.97
3.04	Radioisotope Room	7	158	1,106	35.0	38.71	10%	3.87
3.05	Growth Chambers/Equipment Room	3	315	945	35.0	33.08	25%	8.27
3.06	Insectaries	3	210	630	35.0	22.05	25%	5.51
3.07	Arabidopsis Rooms	3	210	630	35.0	22.05	100%	22.05
3.08	Cell Culture Room	14	210	2,940	35.0	102.90	100%	102.90
3.09	Fume Hood Alcove/Chemical Storage	32	84	2,688	35.0	94.08	25%	23.52
3.10	Cluster Farm (Bioinformatics)	1	500	500	150.0	75.00	100%	75.00
3.11	Controlled Temperature Room (+4 deg. C)	8	119	952	35.0	33.32	25%	8.33
3.12	Cryo Storage	2	105	210	35.0	7.35	25%	1.84
Lab Support Subtotal				14,015		548.03 kVA		323.33 kVA
GENOMICS OFFICE/ADMIN/CONF								
4.01	Faculty Office (PI)	36	132	4,752	2.0	9.50	10%	0.95
4.02	Post Docs	72	60	4,320	2.0	8.64	10%	0.86
4.03	Grad Students	108	40	4,320	2.0	8.64	10%	0.86
4.04	Administrative Support	6	120	720	2.0	1.44	10%	0.14
4.05	Work Study Student	5	40	200	2.0	0.40	10%	0.04
4.06	Coffee / Interaction	1	145	145	2.0	0.29	10%	0.03
4.07	Copy/Mail/Workroom	1	269	269	1.0	0.27	10%	0.03
4.08	Storage	4	264	1,056	0.8	0.84	10%	0.08
4.10	Conference Facility (Dean's Office)	1	2,730	2,730	8.0	21.84	10%	2.18
Support Subtotal				18,512		51.87 kVA		5.19 kVA
BUILDING SUPPORT								
5.01	Loading Dock	1	300	300	1.0	0.30	10%	0.03
5.02	Telecommunication/Server	2	132	264	1.0	0.26	10%	0.03
Building Support Subtotal				564		.56 kVA		.06 kVA
PROGRAM TOTAL ASF				63,986		1218.36 kVA		390.36 kVA
TOTAL BUILDING GSF				110,321				

MECHANICAL / PLUMBING MOTOR LOADS						NORMAL POWER				STANDBY POWER			
	Location	Motor Description	Qty	Voltage	Ph	HP	KW	FLA	kVA	HP	KW	FLA	kVA
MCC1		Air Handling Unit	2	480	3	100	124.0		164.95				
		Exhaust Fan	2	480	3	60	77.0		102.43				
		Exhaust Fan (Radioisotope)	3	480	3	5	7.6		15.16				
		Total on MCC							282.54				
MCC2		Chilled Water Pump	1	480	3	50	65.0		43.23				
		Hot Water System	1	480	3	25	34.0		22.61				
		Elevator	1	480	3	75	96.0		63.85				
		Total on MCC							129.70				
SMCC1		Air Handling Unit	2	480	3					100	124.0		164.95
		Exhaust Fan	2	480	3					60	77.0		102.43
		Exhaust Fan (Radioisotope)	4	480	3					5	7.6		20.22
		Total on MCC											287.59
SMCC2		Chilled Water Pump	1	480	3					50	65.0		43.23
		Hot Water System	1	480	3					25	34.0		22.61
		Cluster Farm A/C Unit	2	480	3					3	4.8		6.39
		Elevator	1	480	3					75	96.0		63.85
		Total on MCC											136.08
TOTAL MECHANICAL/PLUMBING LOADS									412.23				423.67

Electrical Equipment Schedule

Equipment	Manufacturer	Size (Each)	Total Quantity	Remarks
One Double Ended Unit Substation (US1, US2)	Cutler-Hammer, Square D, GE	Primary: 60A, 12.47 kV, 3 PH, 4W Secondary: 1,500A, 480Y/277V, 3 PH, 4W	2	Drawout Breakers, A.I.C. to be Determined
Transformer (TX-1, TX-2)	Cutler-Hammer, Square D, GE	1,000 kVA, 12.47 kV-480Y/277V, 3 PH, 4W	2	Cast Coil Dry Type
Generator	Caterpillar, Kato, Onan	600 kW / 750 kVA , 480Y/277V, 3 PH, 4W	1	Diesel, W/Outdoor Enclosure
Sec. Transformer	Cutler-Hammer, Square D, GE	225 kVA, 480V/208Y/120V, 3 PH	TBD	Dry Type
Lighting Panel	Cutler-Hammer, Square D, GE	42 CKT , 100A Mains, 3 PH, 4W	TBD	A.I.C. to be Determined
Power Panel	Cutler-Hammer, Square D, GE	42 CKT , 225A Mains, 3 PH, 4W	TBD	Final Quantity to be Determined
Lab Panel	Cutler-Hammer, Square D, GE	42 CKT , 225A Mains 3 PH, 4W	TBD	Final Quantity to be Determined
Emergency Distribution Panel	Cutler-Hammer, Square D, GE	800A Mains, 3 PH, 4W	TBD	Final Circuit Quantity to be Determined
Distribution Panel	Cutler-Hammer, Square D, GE	400A Mains, 3 PH, 4W	TBD	Final Circuit Quantity to be Determined
Emergency Sec. Transformer	Cutler-Hammer, Square D, GE	75 kVA, 480V-208Y/120V, 3 PH	TBD	Dry Type